

Cube evaporative condenser

DTC INDUCED DRAFT MODELS

engineering data
and specifications



Cube Draw-Through Evaporative Condenser

The Cube represents the synergy derived from combining the efforts and strengths of two companies to create better solutions for the refrigeration industry.

Cube Evaporative Condensers are the result of a unique collaboration between SPX Cooling Technologies, Inc. and SGS Refrigeration, Inc. By capitalizing on the unique capabilities and strengths of two companies, Cube Evaporative Condensers offer customers several advantages:

- **ROBUST CONSTRUCTION**

Strong galvanized steel houses high quality mechanical and heat transfer systems. Stainless steel component options allow customization to address the most demanding environmental and service life requirements.

- **RESPONSIVENESS**

There are numerous evaporative condensers available that can meet your design and performance criteria. What separates the field is the level of service you can expect from your supplier. From specification review, product selection assistance and on-time delivery to installation coordination and ongoing operational support, SGS Refrigeration's customer service and sales teams provide an extra measure of attention, know-how and commitment to your satisfaction.

DRAW-THROUGH (INDUCED DRAFT) MODELS

Choose from a broad selection of DTC models in 8.5', 10' and 12' nominal widths and nominal lengths from 9' to 36' to meet your specific refrigeration requirements.

UPDATE™ PROPRIETARY PRODUCT SELECTION SOFTWARE

The UPDATE product software takes the guesswork out of product selection and helps specifiers of refrigeration systems evaluate several product configurations and criteria in order to make informed choices.

MANUFACTURED IN AMERICA

The Cube Evaporative Condenser is totally fabricated and assembled at SPX and SGS manufacturing plants in the U.S. From tube production and bending, welding, parts fabrication and assembly, condenser components are produced, inspected, assembled and performance-tested to our high standards of quality.

NATIONWIDE SUPPORT

The SGS network of sales and service specialists are ready to provide you the most responsive and knowledgeable airside refrigeration products support across the United States. Rely on us for expert selection, installation and operational assistance. Visit sgsrefrigeration.com to locate your SGS technical representative.



- **PARTNERSHIP**

SGS Refrigeration and SPX Cooling Technologies capitalized on their unique capabilities to produce and sell refrigeration products with more value for our customers. Cube Evaporative Condensers take advantage of the engineering and production strengths of our two independent companies as well as the shared business philosophy that meeting customer expectations is paramount to long term success. Customers benefit from the partnership in two ways: the Cube is a well-engineered, robust and reliable product; and the partners are committed to customer satisfaction throughout the life of the product.

STRONG GALVANIZED STEEL CONSTRUCTION

The high quality mechanical components and refrigeration coils are safely housed in heavy-duty galvanized steel to ensure corrosion protection, low maintenance and long life. Submerged areas are bolted or welded to minimize potential for leaks; tap screws are not used in submerged areas.

STAINLESS STEEL OPTIONS

When environmental and design conditions dictate, heavy gauge stainless steel water collection basins and other structural components may be specified.

DUAL U-BOLT FAN HUB

The hub design reduces fan de-pitching and vibration potential.

CLOG-RESISTANT WATER DISTRIBUTION SYSTEM

Self-draining spray headers and large orifice spray nozzles help prevent debris build-up and clogging. Self-draining spray headers limit potential ice buildup when not operational; spray nozzles mount to the bottom of the spray pipes.

SOUND REDUCTION

Quiet operation is increasingly an important part of product specifications. Sound reduction options enable induced draft selections with sound levels up to 15+ dbA lower than similar steel forced draft condensers.

MARLEY GEAREDUCER® DRIVE

Genuine Marley mechanical system offers lowest maintenance costs and most reliable performance with 5-year warranty. Belt drive optional.

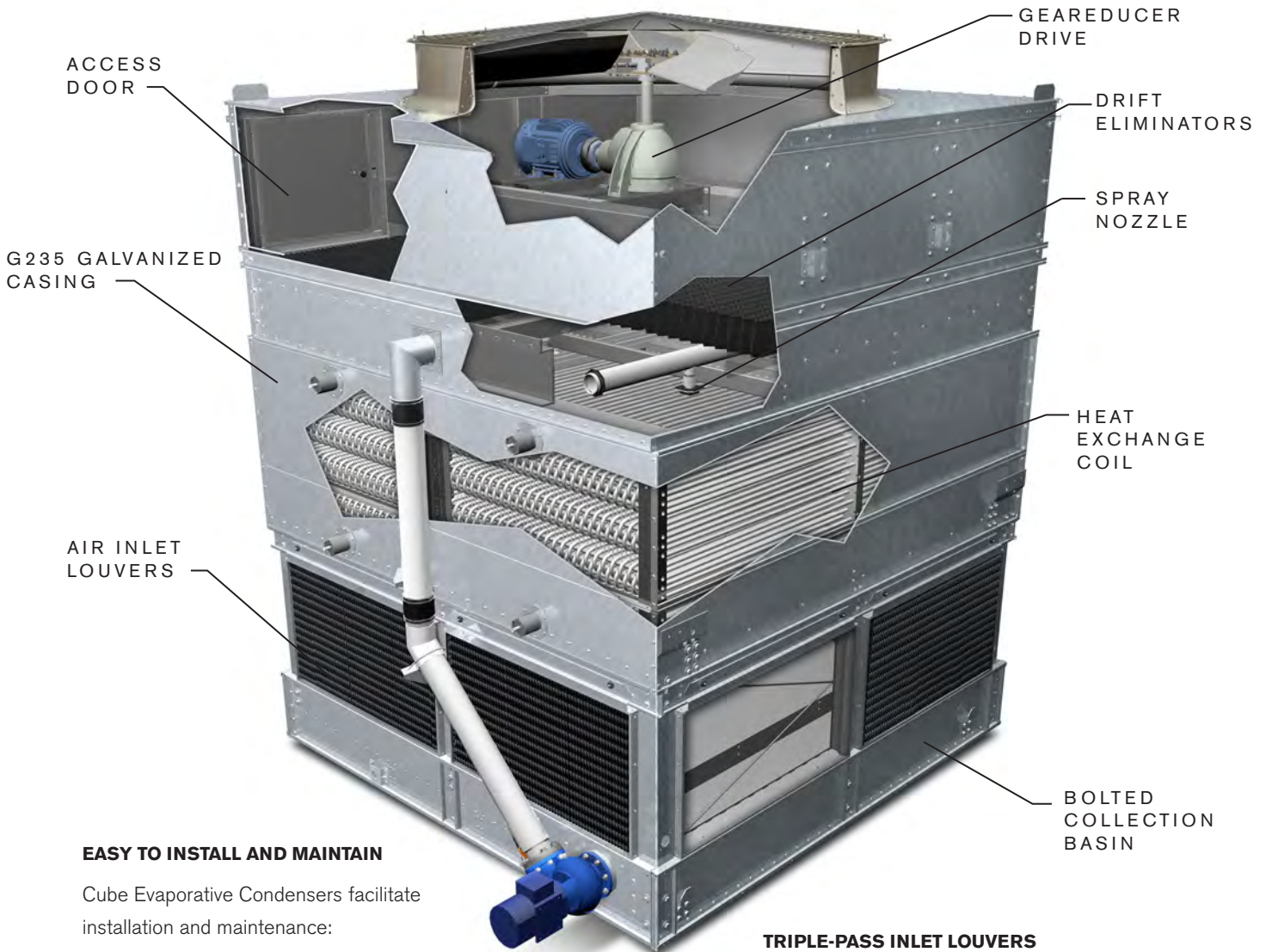

EASY TO INSTALL AND MAINTAIN

Cube Evaporative Condensers facilitate installation and maintenance:

- Module connections require minimal fasteners
- Pre-assembled platform options have welded guardrails

TRIPLE-PASS INLET LOUVERS

Removable louvers control splash-out and sunlight exposure to limit algae growth.

Access Platforms

Condenser-supported mechanical access platforms are available on the condenser face where the mechanical access door is located. Platform surfaces are surrounded by a guardrail, kneerail and toeboard designed according to OSHA guidelines. Partial factory assembled platforms are available to simplify field installation. Available platform accessories include ladder(s), ladder extension(s), safety cage(s) and safety gate(s).

Remote Sump Application

For applications with remote sump, the condenser recirculating water pump and piping are removed and an outlet connection is added in the collection basin.

Belt Drive

The standard mechanical drive system consists of a Marley Geareducer coupled to a NEMA premium efficiency, TEFC inverter duty motor. A drive system consisting of belts and pulleys may alternatively be selected based on user preference.

Vibration Switch

A mechanical vibration switch may be factory mounted for wiring to the shutdown circuit of the fan motor starter or VFD. The switch is designed to interrupt control power voltage to a safety circuit in the event of excessive vibration causing the starter or VFD equipment to de-energize the motor.

Quiet Fans

Standard low sound fans are designed to maximize air movement efficiency at low sound levels. Quiet fans provide lower sound levels with minimal cost impact by increasing blade count and/or reducing fan speed.

Ultra Quiet Fans

For applications requiring a significant reduction in condenser sound levels, Ultra Quiet fans may be employed to reduce above fan sound levels up to 16 dBA. Fans are propeller-type, incorporating wide-chord acoustic geometry, individually adjustable, corrosion and fire resistant marine grade aluminum blades resiliently mounted to an aluminum hub.

Lube Line and Dipstick

An external oil level dipstick can be selected on condensers with Geareducer drive.

Davit Crane

To simplify the removal of mechanical components, condenser-mounted portable davit cranes are available in 500 lb and 1000 lb capacities.

Stainless Steel Construction

When an enhanced level of corrosion protection is desired, condensers may be configured with varying levels of stainless steel construction. Stainless steel collection basins, welded and factory water tested to reduce the potential for leaks, are a commonly selected upgrade. Units with stainless steel collection basin and casing are also available.

Electronic Water Level Control

An electronic water level control system consisting of a NEMA 4X control panel, water level probes and probe stilling chamber may be selected to monitor the water level in the collection basin to determine level events used for makeup, high/low alarm(s), and/or pump shutdown.

Water Level Standpipe

An external water level standpipe is available to allow visual determination of the basin water level from the exterior of the unit while in operation.

Pump Heat Trace

When an electric basin heater package is selected, the recirculating pump(s) may be fitted with electric heat trace cable and insulated to protect the water retained in the pump from freezing during periods of shutdown or standby operation.

Basin Sweeper Piping

As an option to augment an external filtration system, the collection basin may be equipped with a factory installed corrosion resistant sweeper piping system designed to force dirt and debris towards a dedicated drain in the depressed section of the collection basin.

Splash Attenuation

Condensers may be selected with optional polypropylene splash attenuation media, factory installed in the collection basin to reduce falling water noise at the air inlet.

MODEL NOMENCLATURE

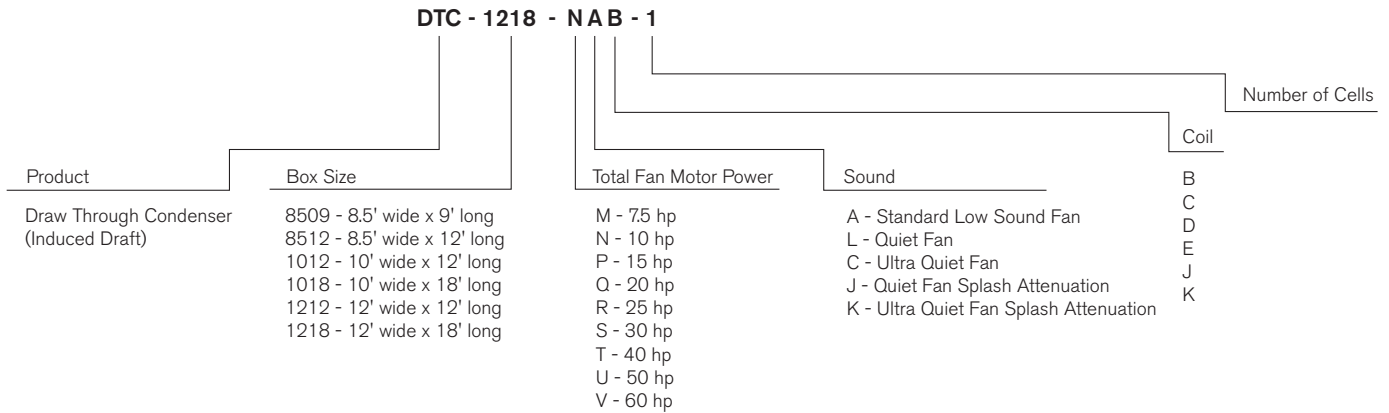

HEAT REJECTION METHOD

There are several commonly used methods for selecting an evaporative condenser as part of a mechanical refrigeration system. The most accurate method sizes a condenser based on the Total Heat Rejection required at a given condensing duty. Total Heat Rejection is defined as the sum of the heat input at the evaporator and the energy input at the compressor.

1. Establish the Design Duty

- a. Refrigerant
- b. Condensing Temperature - °F
- c. Wet-Bulb Temperature - °F
- d. Total Heat Rejection required - MBH

Open Compressors:

$$\text{THR (MBH)} = \text{Compressor Evaporator Capacity (MBH)} + \text{Compressor Power (bhp)} \times 2.545$$

Hermetic Compressors:

$$\text{THR (MBH)} = \text{Compressor Evaporator Capacity (MBH)} + \text{Compressor Input (kW)} \times 3.415$$

- Note:
- 1 MBH = 1000 Btu/hr
 - 1 Ton = 12 MBH
 - 1 kW = 3.415 MBH
 - 1 hp = 2.545 MBH
 - 1 kW = 1.341 hp
 - 1 °F = 1.8 °C + 32

2. Determine the Heat Rejection Capacity Factor

- a. Select the appropriate Heat Rejection Capacity Factor table based on the system Refrigerant.
 - 1. **Table 2** – Ammonia R717
 - 2. **Table 3** – HFC and HCFC

- b. Find the Heat Rejection Capacity Factor corresponding to the design Condensing Temperature and design Wet-Bulb Temperature.

3. Calculate the Corrected Heat Rejection

Multiply the Total Heat Rejection from **Step 1** by the Heat Rejection Capacity Factor from **Step 2** to obtain the Corrected Heat Rejection.

4. Select an Evaporative Condenser Model

Select an Evaporative Condenser model with a Base Heat Rejection **Table 1** greater than or equal to the Corrected Heat Rejection calculated in **Step 3**. If the Corrected Heat Rejection exceeds table values, multiple cells are required.

Model	Base Heat Rejection MBH
DTC-8509-MAB1	2,809.3
DTC-8509-NAB1	2,968.9
DTC-8509-PAB1	3,260.9
DTC-8509-QAB1	3,401.4
DTC-8509-MAC1	3,060.2
DTC-8509-NAC1	3,246.6
DTC-8509-PAC1	3,572.4
DTC-8509-QAC1	3,734.9
DTC-8509-MAD1	3,248.5
DTC-8509-NAD1	3,456.7
DTC-8509-PAD1	3,830.1
DTC-8509-QAD1	3,989.0
DTC-8509-MAJ1	3,329.0
DTC-8509-NAJ1	3,528.0
DTC-8509-PAJ1	3,868.9
DTC-8509-QAJ1	4,029.6
DTC-8509-MAE1	3,411.7
DTC-8509-NAE1	3,645.1
DTC-8509-PAE1	4,033.6
DTC-8509-QAE1	4,226.1
DTC-8509-MAK1	3,461.9
DTC-8509-NAK1	3,694.5
DTC-8509-PAK1	4,079.1
DTC-8509-QAK1	4,255.4

Model	Base Heat Rejection MBH
DTC-8512-NAB1	3,832.4
DTC-8512-PAB1	4,214.3
DTC-8512-QAB1	4,438.5
DTC-8512-RAB1	4,588.4
DTC-8512-NAC1	4,213.7
DTC-8512-PAC1	4,625.4
DTC-8512-QAC1	4,878.0
DTC-8512-RAC1	5,046.3
DTC-8512-NAD1	4,482.6
DTC-8512-PAD1	4,952.3
DTC-8512-QAD1	5,246.8
DTC-8512-RAD1	5,422.2
DTC-8512-SAD1	5,545.3
DTC-8512-NAJ1	4,579.4
DTC-8512-PAJ1	4,992.9
DTC-8512-QAJ1	5,249.3
DTC-8512-RAJ1	5,430.1
DTC-8512-SAJ1	5,527.0
DTC-8512-NAE1	4,712.1
DTC-8512-PAE1	5,211.6
DTC-8512-QAE1	5,509.7
DTC-8512-RAE1	5,700.5
DTC-8512-SAE1	5,886.5
DTC-8512-NAK1	4,739.1
DTC-8512-PAK1	5,261.8
DTC-8512-QAK1	5,532.9
DTC-8512-RAK1	5,708.2
DTC-8512-SAK1	5,825.2

Model	Base Heat Rejection MBH
DTC-1012-NAB1	4,227.9
DTC-1012-PAB1	4,642.4
DTC-1012-QAB1	4,930.8
DTC-1012-RAB1	5,128.5
DTC-1012-NAC1	4,761.5
DTC-1012-PAC1	5,098.4
DTC-1012-QAC1	5,450.7
DTC-1012-RAC1	5,761.6
DTC-1012-NAD1	4,911.8
DTC-1012-PAD1	5,318.3
DTC-1012-QAD1	5,674.9
DTC-1012-RAD1	6,134.6
DTC-1012-SAD1	6,472.6
DTC-1012-NAJ1	5,192.1
DTC-1012-PAJ1	5,591.8
DTC-1012-QAJ1	5,959.9
DTC-1012-RAJ1	6,212.3
DTC-1012-SAJ1	6,549.1
DTC-1012-PAE1	5,734.7
DTC-1012-QAE1	6,145.9
DTC-1012-RAE1	6,451.7
DTC-1012-SAE1	6,704.2
DTC-1012-PAK1	5,837.4
DTC-1012-QAK1	6,242.3
DTC-1012-RAK1	6,536.1
DTC-1012-SAK1	6,777.1

Model	Base Heat Rejection MBH
DTC-1212-NAB1	5,025.8
DTC-1212-PAB1	5,523.2
DTC-1212-QAB1	5,876.6
DTC-1212-RAB1	6,126.7
DTC-1212-SAB1	6,428.2
DTC-1212-NAC1	5,665.3
DTC-1212-PAC1	6,051.7
DTC-1212-QAC1	6,486.9
DTC-1212-RAC1	6,839.3
DTC-1212-SAC1	7,184.2
DTC-1212-NAD1	5,996.5
DTC-1212-PAD1	6,501.3
DTC-1212-QAD1	6,935.8
DTC-1212-RAD1	7,256.7
DTC-1212-SAD1	7,703.3
DTC-1212-PAJ1	6,564.8
DTC-1212-QAJ1	7,025.8
DTC-1212-RAJ1	7,419.6
DTC-1212-SAJ1	7,846.3
DTC-1212-TAJ1	8,290.0
DTC-1212-PAE1	6,653.3
DTC-1212-QAE1	7,086.5
DTC-1212-RAE1	7,472.3
DTC-1212-SAE1	7,850.9
DTC-1212-PAK1	6,749.0
DTC-1212-QAK1	7,288.8
DTC-1212-RAK1	7,668.3
DTC-1212-SAK1	8,020.6
DTC-1212-TAK1	8,600.9

Model	Base Heat Rejection MBH
DTC-1018-NAB1	6,108.2
DTC-1018-PAB1	6,598.6
DTC-1018-QAB1	6,994.6
DTC-1018-RAB1	7,295.4
DTC-1018-SAB1	7,682.1
DTC-1018-NAC1	6,585.8
DTC-1018-PAC1	7,179.6
DTC-1018-QAC1	7,613.1
DTC-1018-RAC1	7,979.4
DTC-1018-SAC1	8,432.8
DTC-1018-NAD1	6,949.0
DTC-1018-PAD1	7,587.1
DTC-1018-QAD1	8,122.2
DTC-1018-RAD1	8,506.1
DTC-1018-SAD1	8,997.8
DTC-1018-TAD1	9,577.1
DTC-1018-PAJ1	7,841.2
DTC-1018-QAJ1	8,392.7
DTC-1018-RAJ1	8,798.2
DTC-1018-SAJ1	9,199.9
DTC-1018-TAJ1	9,719.8
DTC-1018-PAE1	7,946.9
DTC-1018-QAE1	8,546.9
DTC-1018-RAE1	8,965.4
DTC-1018-SAE1	9,506.5
DTC-1018-TAE1	10,118.7
DTC-1018-PAK1	8,086.4
DTC-1018-QAK1	8,725.5
DTC-1018-RAK1	9,177.7
DTC-1018-SAK1	9,668.9
DTC-1018-TAK1	10,228.6

Model	Base Heat Rejection MBH
DTC-1218-PAB1	7,689.0
DTC-1218-QAB1	8,207.1
DTC-1218-RAB1	8,581.9
DTC-1218-SAB1	8,980.7
DTC-1218-PAC1	8,414.4
DTC-1218-QAC1	9,015.4
DTC-1218-RAC1	9,492.1
DTC-1218-SAC1	9,906.6
DTC-1218-PAD1	8,953.2
DTC-1218-QAD1	9,649.1
DTC-1218-RAD1	10,115.3
DTC-1218-SAD1	10,549.0
DTC-1218-TAD1	11,301.6
DTC-1218-UAD1	12,207.0
DTC-1218-QAJ1	9,881.8
DTC-1218-RAJ1	10,300.3
DTC-1218-SAJ1	10,851.4
DTC-1218-TAJ1	11,523.1
DTC-1218-UAJ1	12,029.1
DTC-1218-VAJ1	12,517.9
DTC-1218-QAE1	9,856.4
DTC-1218-RAE1	10,314.9
DTC-1218-SAE1	10,821.9
DTC-1218-TAE1	11,675.9
DTC-1218-UAE1	12,224.2
DTC-1218-QAK1	10,093.1
DTC-1218-RAK1	11,085.6
DTC-1218-SAK1	11,150.1
DTC-1218-TAK1	11,979.1
DTC-1218-UAK1	12,642.3
DTC-1218-VAK1	13,181.1

Table 1 Base Heat Rejection

Table data is per cell. For multiple cell selections, multiply Base Heat Rejection by number of cells.

Ammonia R717 Heat Rejection Capacity Factors																		
Condensing Pressure psig	Condensing Temperature °F	Entering Wet-Bulb Temperature °F																
		50	52	54	56	58	60	62	64	66	68	70	72	74	76	78	80	82
R717																		
151.3	85	0.98	1.02	1.06	1.12	1.18	1.25	1.33	1.43	1.56	1.71	1.90	2.15	2.49	2.99	3.77	-	-
154.1	86	0.94	0.98	1.03	1.07	1.13	1.20	1.27	1.36	1.47	1.60	1.77	1.99	2.27	2.68	3.28	-	-
156.9	87	0.91	0.95	0.99	1.03	1.09	1.15	1.22	1.30	1.39	1.51	1.66	1.85	2.09	2.42	2.90	3.66	-
159.8	88	0.88	0.92	0.95	1.00	1.04	1.10	1.16	1.24	1.33	1.43	1.56	1.72	1.93	2.21	2.60	3.19	-
162.6	89	0.86	0.89	0.92	0.96	1.01	1.06	1.11	1.18	1.26	1.36	1.47	1.61	1.79	2.03	2.35	2.82	3.56
165.5	90	0.83	0.86	0.89	0.93	0.97	1.02	1.07	1.13	1.20	1.29	1.39	1.52	1.67	1.88	2.15	2.53	3.10
168.5	91	0.81	0.83	0.86	0.90	0.94	0.98	1.03	1.08	1.15	1.23	1.32	1.43	1.57	1.75	1.98	2.29	2.74
171.5	92	0.78	0.81	0.84	0.87	0.90	0.94	0.99	1.04	1.10	1.17	1.25	1.35	1.48	1.63	1.83	2.09	2.46
174.5	93	0.76	0.78	0.81	0.84	0.87	0.91	0.95	1.00	1.05	1.12	1.19	1.28	1.39	1.53	1.70	1.92	2.23
177.6	94	0.74	0.76	0.79	0.81	0.85	0.88	0.92	0.96	1.01	1.07	1.14	1.22	1.32	1.44	1.58	1.78	2.03
180.7	95	0.72	0.74	0.76	0.79	0.82	0.85	0.89	0.93	0.97	1.03	1.09	1.16	1.25	1.35	1.49	1.65	1.87
185.0	96.3	0.69	0.71	0.74	0.76	0.79	0.81	0.85	0.88	0.93	0.97	1.03	1.09	1.17	1.26	1.37	1.51	1.69
187.0	97	0.68	0.70	0.72	0.74	0.77	0.80	0.83	0.86	0.90	0.95	1.00	1.06	1.13	1.22	1.32	1.45	1.61
190.2	98	0.66	0.68	0.70	0.72	0.75	0.77	0.80	0.83	0.87	0.91	0.96	1.01	1.08	1.16	1.25	1.36	1.50
193.4	99	0.65	0.66	0.68	0.70	0.72	0.75	0.78	0.81	0.84	0.88	0.92	0.97	1.03	1.10	1.18	1.28	1.41
196.7	100	0.63	0.65	0.66	0.68	0.70	0.73	0.75	0.78	0.81	0.85	0.89	0.93	0.99	1.05	1.12	1.21	1.32
213.7	105	0.56	0.57	0.58	0.60	0.61	0.63	0.65	0.67	0.69	0.72	0.74	0.78	0.81	0.85	0.90	0.95	1.02
231.8	110	0.50	0.51	0.52	0.53	0.54	0.55	0.57	0.58	0.60	0.62	0.64	0.66	0.68	0.71	0.74	0.78	0.82

Table 2 Ammonia R717 Heat Rejection Capacity Factors

HFC and HCFC Heat Rejection Capacity Factors																			
Condensing Pressure psig	Condensing Temperature °F	Entering Wet-Bulb Temperature °F																	
		50	52	54	56	58	60	62	64	66	68	70	72	74	76	78	80	82	
R404A	R507A																		
189.5	193.9	85	1.09	1.13	1.19	1.25	1.31	1.39	1.49	1.60	1.74	1.90	2.12	2.40	2.78	3.33	-	-	-
192.4	196.8	86	1.05	1.09	1.14	1.20	1.26	1.33	1.42	1.52	1.64	1.79	1.97	2.21	2.53	2.98	3.65	4.77	-
195.4	199.8	87	1.02	1.06	1.10	1.15	1.21	1.28	1.35	1.45	1.55	1.69	1.85	2.06	2.33	2.70	3.23	4.07	-
198.4	202.9	88	0.99	1.02	1.06	1.11	1.16	1.23	1.30	1.38	1.48	1.59	1.74	1.92	2.15	2.46	2.90	3.55	4.64
201.4	206.0	89	0.95	0.99	1.03	1.07	1.12	1.18	1.24	1.32	1.41	1.51	1.64	1.80	2.00	2.26	2.62	3.14	3.96
204.4	209.1	90	0.93	0.96	0.99	1.03	1.08	1.13	1.19	1.26	1.34	1.44	1.55	1.69	1.87	2.09	2.39	2.82	3.45
207.5	212.2	91	0.90	0.93	0.96	1.00	1.04	1.09	1.15	1.21	1.28	1.37	1.47	1.59	1.75	1.94	2.20	2.55	3.06
210.7	215.4	92	0.87	0.90	0.93	0.97	1.01	1.05	1.10	1.16	1.23	1.30	1.40	1.51	1.64	1.81	2.03	2.33	2.74
213.8	218.6	93	0.85	0.87	0.90	0.94	0.97	1.01	1.06	1.11	1.18	1.25	1.33	1.43	1.55	1.70	1.89	2.14	2.48
217.0	221.8	94	0.82	0.85	0.88	0.91	0.94	0.98	1.02	1.07	1.13	1.19	1.27	1.36	1.47	1.60	1.76	1.98	2.26
220.2	225.1	95	0.80	0.83	0.85	0.88	0.91	0.95	0.99	1.03	1.08	1.14	1.21	1.29	1.39	1.51	1.65	1.84	2.08
223.5	228.4	96	0.78	0.80	0.83	0.85	0.88	0.92	0.95	1.00	1.04	1.10	1.16	1.23	1.32	1.43	1.56	1.72	1.93
226.8	231.8	97	0.76	0.78	0.80	0.83	0.86	0.89	0.92	0.96	1.00	1.05	1.11	1.18	1.26	1.35	1.47	1.61	1.79
230.1	235.2	98	0.74	0.76	0.78	0.80	0.83	0.86	0.89	0.93	0.97	1.01	1.07	1.13	1.20	1.29	1.39	1.51	1.67
233.5	238.6	99	0.72	0.74	0.76	0.78	0.81	0.83	0.86	0.90	0.93	0.98	1.03	1.08	1.15	1.23	1.32	1.43	1.57
236.9	242.1	100	0.70	0.72	0.74	0.76	0.78	0.81	0.84	0.87	0.90	0.94	0.99	1.04	1.10	1.17	1.25	1.35	1.47
254.3	259.9	105	0.62	0.64	0.65	0.67	0.68	0.70	0.72	0.75	0.77	0.80	0.83	0.86	0.90	0.95	1.00	1.06	1.13
272.7	278.7	110	0.56	0.57	0.58	0.59	0.60	0.62	0.63	0.65	0.67	0.69	0.71	0.73	0.76	0.79	0.83	0.87	0.91

Table 3 HFC and HCFC Heat Rejection Capacity Factors

EXAMPLE Evaporative Condenser Selection

Design Duty	
Refrigerant	Ammonia
Wet-Bulb Temperature	78°F
Condensing Temperature	96.3°F
Compressor Evaporator Capacity	350 Tons
Compressor Power	400 bhp

Calculations	
Total Heat Rejection	5218 MBH
Capacity Factor	1.37
Corrected Heat Rejection	7148.7 MBH
Model Selection	DTC-1212-SAC1

The **Total Heat Rejection**, THR, is calculated using the formula for open compressors. 350 Tons x 12 MBH/Ton + 400 bhp
 2.545 MBH/BHP = 5218 MBH.

Multiplying the **Total Heat Rejection** of 5218 MBH by 1.37 yields a **Corrected Heat Rejection** of 7148.7 MBH. **DTC-1212-SAC1** is the smallest Model Selection with a Base Heat Rejection **Table 1** greater than 7148.7 MBH.

From the **Ammonia** Refrigerant Capacity Factor **Table 2**, at a 78°F **Wet-Bulb Temperature** and a 96.3°F **Condensing Temperature**, the **Heat Rejection Capacity Factor** is 1.37.

8.5' x 9' Single Cell

Use this data for preliminary layouts only. Obtain current drawing from your sales representative.

UPDATE™ web-based selection software, available at spxcooling.com/update provides Cube model recommendations based on customer's specific design requirements.

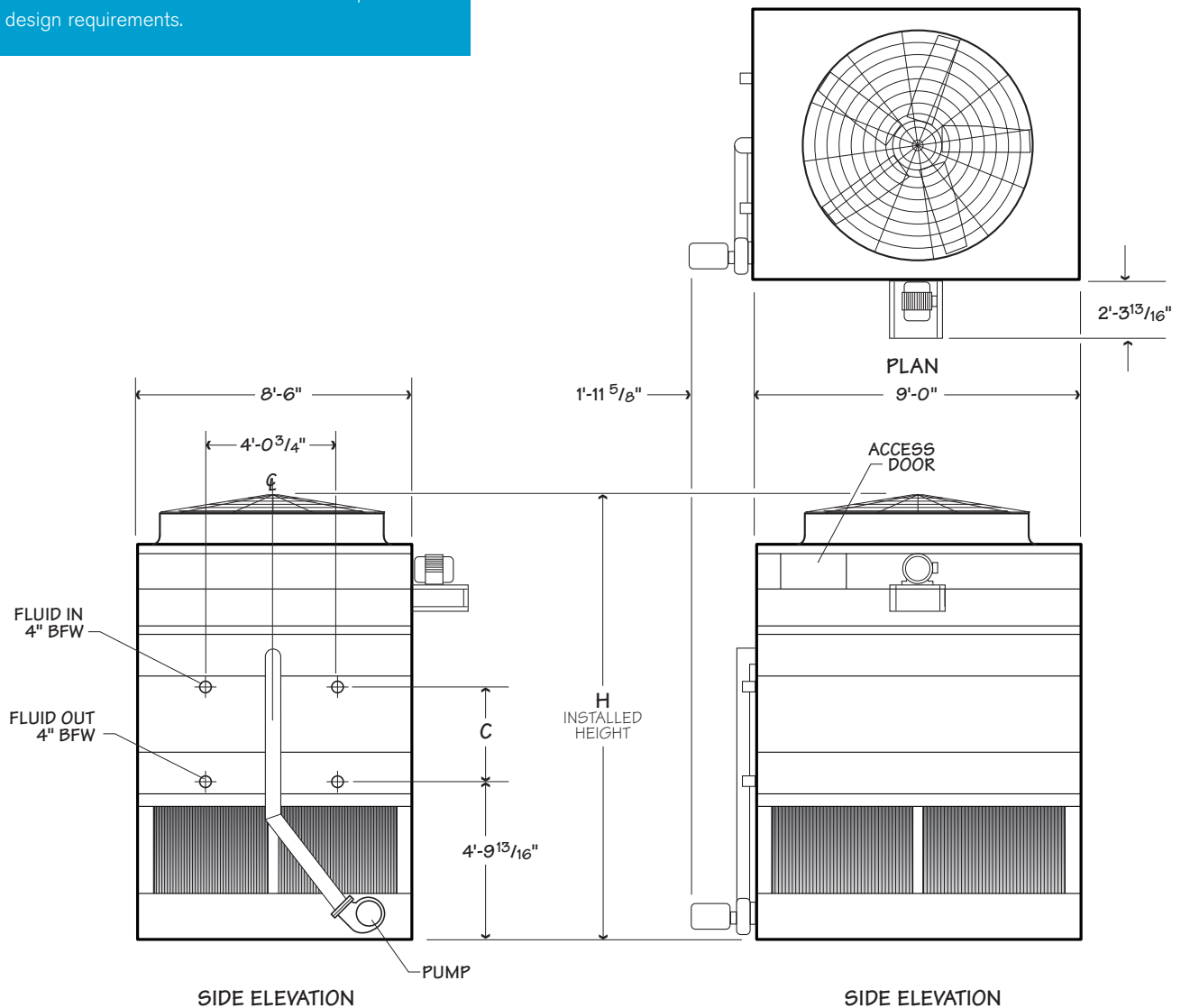

NOTE

1. The last digit of the model number shown represents the number of cells.
2. R717 tons are at 96.3°F condensing temperature, a 20°F suction temperature and a 78°F entering wet-bulb temperature.
3. For R134a charge, multiply by 1.98. For R22 charge multiply by 1.93. For R404A or R507A charge multiply by 1.65.
4. **Use this bulletin for preliminary layouts only.** Obtain current drawings from your sales representative.

Model note 1	Base Heat Rejection MBH	R717 Capacity tons - note 2	Fan Motor hp	Airflow Rate cfm	Shipping Weight lb		Design Operating Weight lb	Dimensions	
					Weight/Cell	Heaviest Section		H	C
DTC-8509-MAB1	2,809.3	136	7.5	39,374	9,100	7,600	11,700	12'-7 3/8"	2'-8 1/8"
DTC-8509-NAB1	2,968.9	143	10	42,317	9,100	7,600	11,800		
DTC-8509-PAB1	3,260.9	157	15	46,892	9,300	7,700	11,900		
DTC-8509-QAB1	3,401.4	164	20	48,762	9,300	7,700	11,900		
DTC-8509-MAC1	3,060.2	148	7.5	38,987	10,200	8,600	12,800	13'-4 3/8"	3'-5 1/8"
DTC-8509-NAC1	3,246.6	157	10	42,012	10,200	8,600	12,900		
DTC-8509-PAC1	3,572.4	172	15	46,679	10,300	8,700	13,000		
DTC-8509-QAC1	3,734.9	180	20	48,563	10,300	8,800	13,000		
DTC-8509-MAD1	3,248.5	157	7.5	38,586	11,200	9,600	13,900	14'-1 3/8"	4'-2 1/8"
DTC-8509-NAD1	3,456.7	167	10	41,700	11,200	9,700	13,900		
DTC-8509-PAD1	3,830.1	185	15	46,468	11,300	9,800	14,100		
DTC-8509-QAD1	3,989.0	192	20	48,367	11,400	9,800	14,100		
DTC-8509-MAJ1	3,329.0	161	7.5	37,579	11,800	10,300	14,600		
DTC-8509-NAJ1	3,528.0	170	10	40,959	11,900	10,300	14,600		
DTC-8509-PAJ1	3,868.9	187	15	46,134	12,000	10,400	14,700		
DTC-8509-QAJ1	4,029.6	194	20	48,299	12,000	10,400	14,800		
DTC-8509-MAE1	3,411.7	165	7.5	38,169	12,300	10,700	15,100	14'-10 3/8"	4'-11 1/8"
DTC-8509-NAE1	3,645.1	176	10	41,380	12,300	10,800	15,100		
DTC-8509-PAE1	4,033.6	195	15	46,256	12,400	10,900	15,200		
DTC-8509-QAE1	4,226.1	204	20	48,174	12,500	10,900	15,300		
DTC-8509-MAK1	3,461.9	167	7.5	36,886	13,000	11,500	15,900		
DTC-8509-NAK1	3,694.5	178	10	40,396	13,100	11,500	15,900		
DTC-8509-PAK1	4,079.1	197	15	45,761	13,200	11,600	16,000		
DTC-8509-QAK1	4,255.4	205	20	47,969	13,200	11,600	16,000		

Model	R717 Charge lb - note 3	Internal Coil Volume ft³	Pump Motor hp	Recirculating Flow Rate gpm	Remote Sump Application		
					Approximate Operating Weight lb	Bottom Outlet Diameter	Volume gal
DTC-8509-MAB1	227	23	2	355	11,000	8"	220
DTC-8509-NAB1	227	23			11,100		
DTC-8509-PAB1	227	23			11,200		
DTC-8509-QAB1	227	23			11,200		
DTC-8509-MAC1	277	28			12,100		
DTC-8509-NAC1	277	28			12,200		
DTC-8509-PAC1	277	28			12,300		
DTC-8509-QAC1	277	28			12,300		
DTC-8509-MAD1	336	34			13,200		
DTC-8509-NAD1	336	34			13,200		
DTC-8509-PAD1	336	34			13,400		
DTC-8509-QAD1	336	34			13,400		
DTC-8509-MAJ1	366	37			13,900		
DTC-8509-NAJ1	366	37			13,900		
DTC-8509-PAJ1	366	37			14,000		
DTC-8509-QAJ1	366	37			14,100		
DTC-8509-MAE1	385	39			14,400		
DTC-8509-NAE1	385	39			14,400		
DTC-8509-PAE1	385	39			14,500		
DTC-8509-QAE1	385	39			14,600		
DTC-8509-MAK1	425	43	15,200				
DTC-8509-NAK1	425	43	15,200				
DTC-8509-PAK1	425	43	15,300				
DTC-8509-QAK1	425	43	15,300				

8.5' x 9' Single Cell

8.5' x 12' Single Cell

Use this data for preliminary layouts only. Obtain current drawing from your sales representative.

UPDATE™ web-based selection software, available at spcooling.com/update provides Cube model recommendations based on customer's specific design requirements.

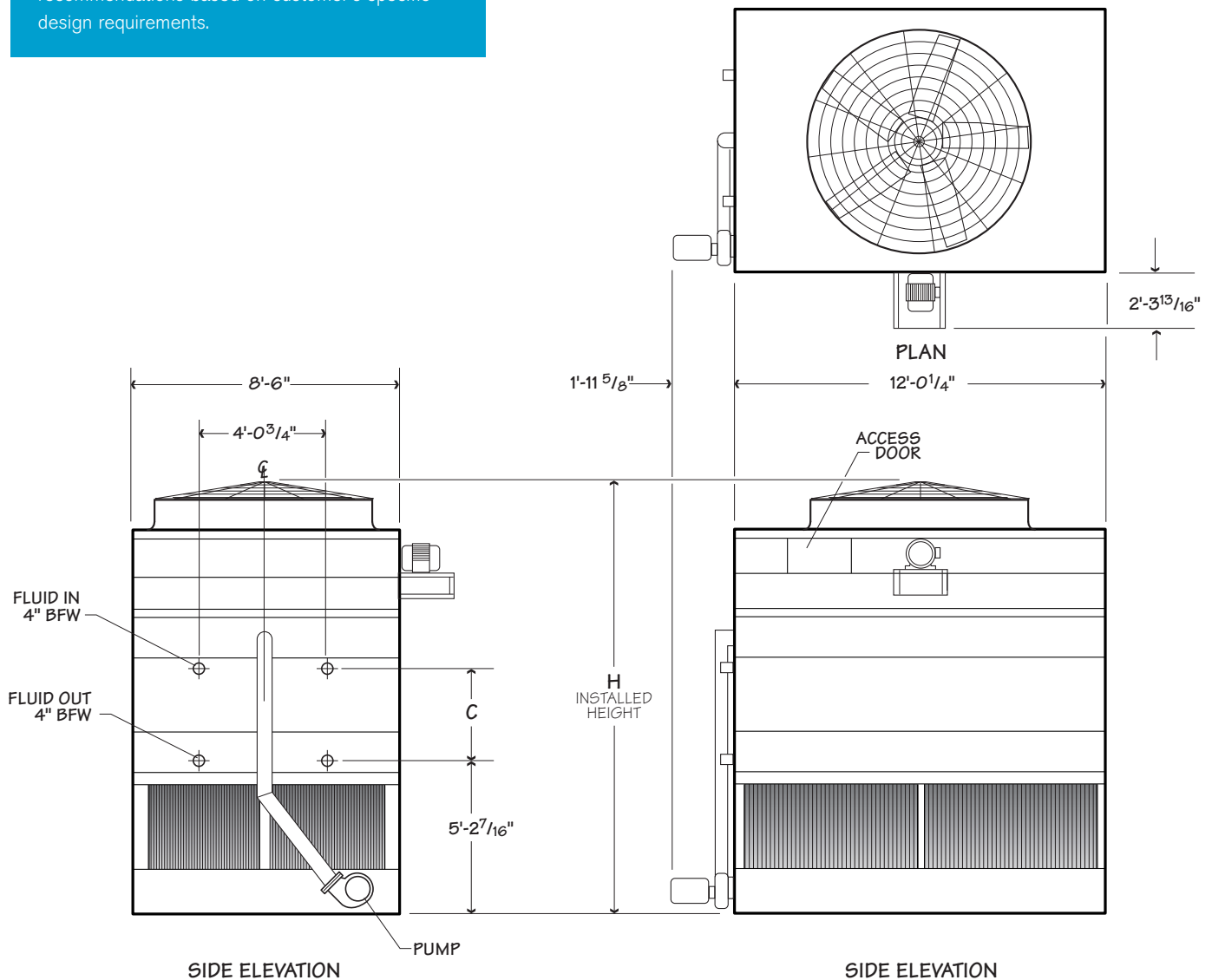

NOTE

1. The last digit of the model number shown represents the number of cells.
2. R717 tons are at 96.3°F condensing temperature, a 20°F suction temperature and a 78°F entering wet-bulb temperature.
3. For R134a charge, multiply by 1.98. For R22 charge multiply by 1.93. For R404A or R507A charge multiply by 1.65.
4. **Use this bulletin for preliminary layouts only.** Obtain current drawings from your sales representative.

Model note 1	Base Heat Rejection MBH	R717 Capacity tons - note 2	Fan Motor hp	Airflow Rate cfm	Shipping Weight lb		Design Operating Weight lb	Dimensions			
					Weight/Cell	Heaviest Section		H	C		
DTC-8512-NAB1	3,832.4	185	10	51,231	10,900	9,000	14,400	13'-0"	2'-8 1/8"		
DTC-8512-PAB1	4,214.3	203	15	57,432	11,000	9,100	14,500				
DTC-8512-QAB1	4,438.5	214	20	60,713	11,000	9,100	14,600				
DTC-8512-RAB1	4,588.4	221	25	62,678	11,200	9,300	14,700				
DTC-8512-NAC1	4,213.7	203	10	50,783	12,200	10,300	15,800	13'-9"	3'-5 1/8"		
DTC-8512-PAC1	4,625.4	223	15	57,132	12,300	10,400	15,900				
DTC-8512-QAC1	4,878.0	235	20	60,453	12,400	10,500	16,000				
DTC-8512-RAC1	5,046.3	243	25	62,436	12,500	10,600	16,100				
DTC-8512-NAD1	4,482.6	216	10	50,320	13,500	11,600	17,200	14'-6"	4'-2 1/8"		
DTC-8512-PAD1	4,952.3	239	15	56,829	13,700	11,800	17,300				
DTC-8512-QAD1	5,246.8	253	20	60,189	13,700	11,800	17,400				
DTC-8512-RAD1	5,422.2	262	25	62,192	13,900	12,000	17,500				
DTC-8512-SAD1	5,545.3	268	30	63,559	13,900	12,000	17,600				
DTC-8512-NAJ1	4,579.4	221	10	49,710	14,400	12,500	18,100				
DTC-8512-PAJ1	4,992.9	241	15	56,059	14,500	12,600	18,200				
DTC-8512-QAJ1	5,249.3	253	20	59,664	14,500	12,600	18,200				
DTC-8512-RAJ1	5,430.1	262	25	61,839	14,700	12,800	18,400				
DTC-8512-SAJ1	5,527.0	267	30	63,335	14,700	12,800	18,400				
DTC-8512-NAE1	4,712.1	227	10	49,838	14,900	13,000	18,700			15'-3"	4'-11 1/8"
DTC-8512-PAE1	5,211.6	251	15	56,518	15,100	13,200	18,800				
DTC-8512-QAE1	5,509.7	266	20	59,923	15,100	13,200	18,800				
DTC-8512-RAE1	5,700.5	275	25	61,948	15,300	13,400	19,000				
DTC-8512-SAE1	5,886.5	284	30	63,694	15,300	13,400	19,000				
DTC-8512-NAK1	4,739.1	229	10	48,261	15,900	14,000	19,700				
DTC-8512-PAK1	5,261.8	254	15	55,484	16,000	14,100	19,800				
DTC-8512-QAK1	5,532.9	267	20	59,158	16,000	14,100	19,800				
DTC-8512-RAK1	5,708.2	275	25	61,375	16,200	14,300	20,000				
DTC-8512-SAK1	5,825.2	281	30	62,899	16,200	14,300	20,000				

Model	R717 Charge lb - note 3	Internal Coil Volume ft³	Pump Motor hp	Recirculating Flow Rate gpm	Remote Sump Application		
					Approximate Operating Weight lb	Bottom Outlet Diameter	Volume gal
DTC-8512-NAB1	306	31	3	530	13,300	8"	270
DTC-8512-PAB1	306	31			13,400		
DTC-8512-QAB1	306	31			13,500		
DTC-8512-RAB1	306	31			13,600		
DTC-8512-NAC1	376	38			14,700		
DTC-8512-PAC1	376	38			14,800		
DTC-8512-QAC1	376	38			14,900		
DTC-8512-RAC1	376	38			15,000		
DTC-8512-NAD1	445	45			16,100		
DTC-8512-PAD1	445	45			16,200		
DTC-8512-QAD1	445	45			16,300		
DTC-8512-RAD1	445	45			16,400		
DTC-8512-SAD1	445	45			16,500		
DTC-8512-NAJ1	494	50			17,000		
DTC-8512-PAJ1	494	50			17,100		
DTC-8512-QAJ1	494	50			17,100		
DTC-8512-RAJ1	494	50			17,300		
DTC-8512-SAJ1	494	50			17,300		
DTC-8512-NAE1	514	52			17,600		
DTC-8512-PAE1	514	52			17,700		
DTC-8512-QAE1	514	52			17,700		
DTC-8512-RAE1	514	52			17,900		
DTC-8512-SAE1	514	52			17,900		
DTC-8512-NAK1	573	58			18,600		
DTC-8512-PAK1	573	58			18,700		
DTC-8512-QAK1	573	58			18,700		
DTC-8512-RAK1	573	58			18,900		
DTC-8512-SAK1	573	58			18,900		

8.5' x 12' Single Cell

10' x 12' Single Cell

Use this data for preliminary layouts only. Obtain current drawing from your sales representative.

UPDATE™ web-based selection software, available at spxcooling.com/update provides Cube model recommendations based on customer's specific design requirements.

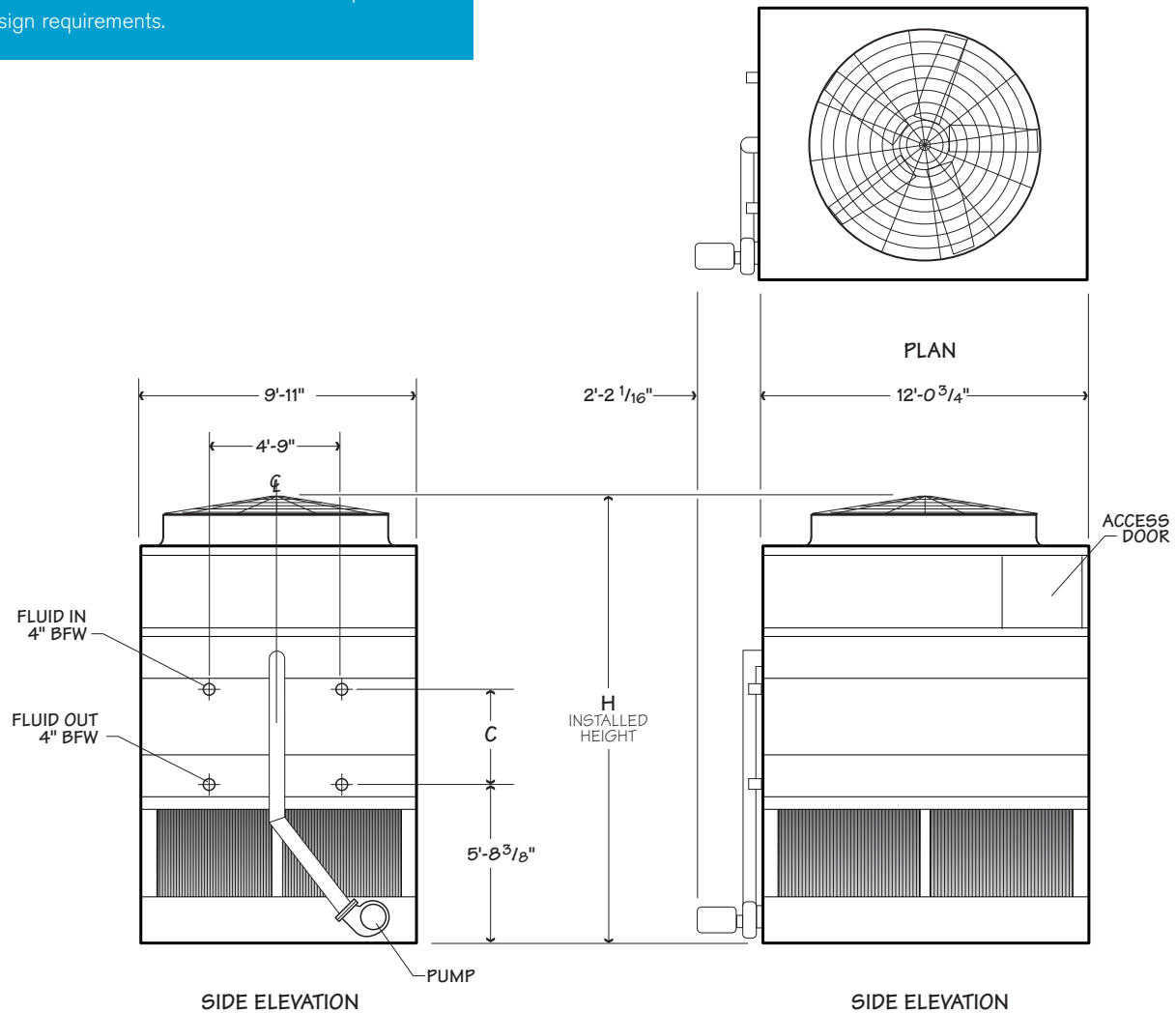

NOTE

1. The last digit of the model number shown represents the number of cells.
2. R717 tons are at 96.3°F condensing temperature, a 20°F suction temperature and a 78°F entering wet-bulb temperature.
3. For R134a charge, multiply by 1.98. For R22 charge multiply by 1.93. For R404A or R507A charge multiply by 1.65.
4. **Use this bulletin for preliminary layouts only.** Obtain current drawings from your sales representative.

Model note 1	Base Heat Rejection MBH	R717 Capacity tons - note 2	Fan Motor hp	Airflow Rate cfm	Shipping Weight lb		Design Operating Weight lb	Dimensions			
					Weight/Cell	Heaviest Section		H	C		
DTC-1012-NAB1	4,227.9	204	10	55,664	13,600	11,400	18,800	15'-2 ⁷ / ₁₆ "	2'-8 ¹ / ₈ "		
DTC-1012-PAB1	4,642.4	224	15	61,038	13,700	11,500	18,900				
DTC-1012-QAB1	4,930.8	238	20	65,814	13,700	11,500	19,000				
DTC-1012-RAB1	5,128.5	247	25	69,129	13,900	11,700	19,100				
DTC-1012-NAC1	4,761.5	230	10	54,949	15,200	13,000	20,500	15'-11 ⁷ / ₁₆ "	3'-5 ¹ / ₈ "		
DTC-1012-PAC1	5,098.4	246	15	60,463	15,300	13,100	20,700				
DTC-1012-QAC1	5,450.7	263	20	65,378	15,300	13,100	20,700				
DTC-1012-RAC1	5,761.6	278	25	68,768	15,500	13,300	20,800				
DTC-1012-NAD1	4,911.8	237	10	54,202	16,800	11,800	22,300	16'-8 ⁷ / ₁₆ "	4'-2 ¹ / ₈ "		
DTC-1012-PAD1	5,318.3	257	15	59,866	16,900	11,800	22,400				
DTC-1012-QAD1	5,674.9	274	20	64,925	16,900	11,800	22,400				
DTC-1012-RAD1	6,134.6	296	25	68,398	17,100	11,800	22,600				
DTC-1012-SAD1	6,472.6	312	30	73,141	17,100	11,800	22,600				
DTC-1012-NAJ1	5,192.1	251	10	52,524	17,800	12,800	23,300				
DTC-1012-PAJ1	5,591.8	270	15	58,445	17,900	12,800	23,500				
DTC-1012-QAJ1	5,959.9	288	20	63,940	17,900	12,800	23,500				
DTC-1012-RAJ1	6,212.3	300	25	67,744	18,100	12,800	23,700				
DTC-1012-SAJ1	6,549.1	316	30	72,986	18,100	12,800	23,700				
DTC-1012-PAE1	5,734.7	277	15	59,243	18,600	13,400	24,200			17'-5 ⁷ / ₁₆ "	4'-11 ¹ / ₈ "
DTC-1012-QAE1	6,145.9	297	20	64,459	18,600	13,400	24,200				
DTC-1012-RAE1	6,451.7	311	25	68,017	18,800	13,400	24,400				
DTC-1012-SAE1	6,704.2	323	30	72,863	18,800	13,400	24,400				
DTC-1012-PAK1	5,837.4	282	15	57,359	19,700	14,600	25,500				
DTC-1012-QAK1	6,242.3	301	20	63,058	19,800	14,600	25,500				
DTC-1012-RAK1	6,536.1	315	25	66,996	19,900	14,600	25,600				
DTC-1012-SAK1	6,777.1	327	30	72,425	20,000	14,600	25,700				

Model	R717 Charge lb - note 3	Internal Coil Volume ft ³	Pump Motor hp	Recirculating Flow Rate gpm	Remote Sump Application		
					Approximate Operating Weight lb	Bottom Outlet Diameter	Volume gal
DTC-1012-NAB1	360	36	5	600	17,600	8"	340
DTC-1012-PAB1	360	36			17,700		
DTC-1012-QAB1	360	36			17,700		
DTC-1012-RAB1	360	36			17,900		
DTC-1012-NAC1	444	45			19,300		
DTC-1012-PAC1	444	45			19,400		
DTC-1012-QAC1	444	45			19,500		
DTC-1012-RAC1	444	45			19,600		
DTC-1012-NAD1	529	54			21,000		
DTC-1012-PAD1	529	54			21,200		
DTC-1012-QAD1	529	54			21,200		
DTC-1012-RAD1	529	54			21,300		
DTC-1012-SAD1	529	54			21,400		
DTC-1012-NAJ1	588	60			22,100		
DTC-1012-PAJ1	588	60			22,200		
DTC-1012-QAJ1	588	60			22,300		
DTC-1012-RAJ1	588	60			22,400		
DTC-1012-SAJ1	588	60			22,500		
DTC-1012-PAE1	614	62			23,000		
DTC-1012-QAE1	614	62			23,000		
DTC-1012-RAE1	614	62			23,200		
DTC-1012-SAE1	614	62			23,200		
DTC-1012-PAK1	683	69			24,200		
DTC-1012-QAK1	683	69			24,300		
DTC-1012-RAK1	683	69			24,400		
DTC-1012-SAK1	683	69			24,500		

10' x 12' Single Cell

12' x 12' Single Cell

Use this data for preliminary layouts only. Obtain current drawing from your sales representative.

UPDATE™ web-based selection software, available at spxcooling.com/update provides Cube model recommendations based on customer's specific design requirements.

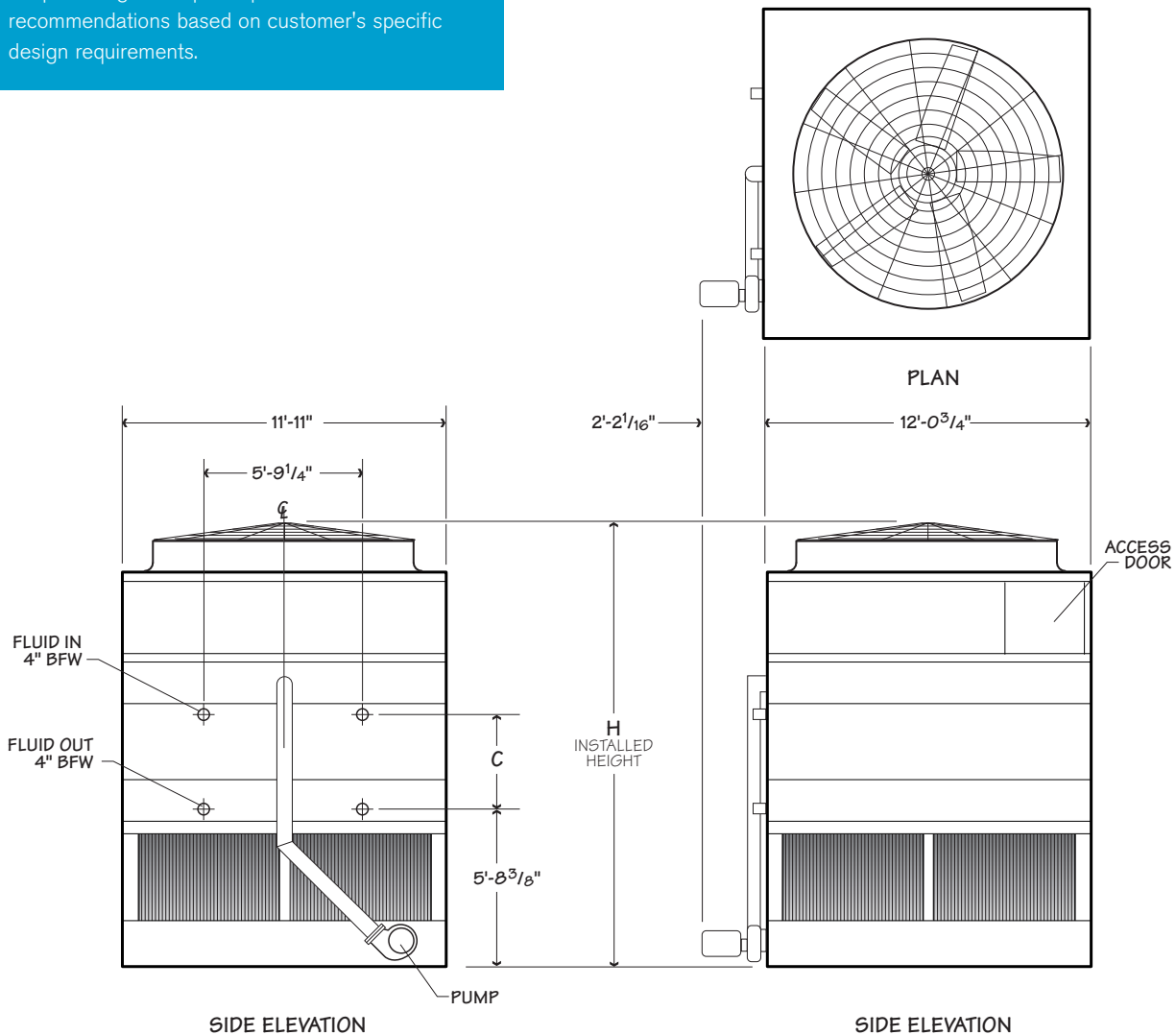

NOTE

1. The last digit of the model number shown represents the number of cells.
2. R717 tons are at 96.3°F condensing temperature, a 20°F suction temperature and a 78°F entering wet-bulb temperature.
3. For R134a charge, multiply by 1.98. For R22 charge multiply by 1.93. For R404A or R507A charge multiply by 1.65.
4. **Use this bulletin for preliminary layouts only.** Obtain current drawings from your sales representative.

Model note 1	Base Heat Rejection MBH	R717 Capacity tons - note 2	Fan Motor hp	Airflow Rate cfm	Shipping Weight lb		Design Operating Weight lb	Dimensions	
					Weight/Cell	Heaviest Section		H	C
DTC-1212-NAB1	5,025.8	243	10	65,604	15,400	11,900	21,900	15'-2 ⁷ / ₁₆ "	2'-8 ¹ / ₈ "
DTC-1212-PAB1	5,523.2	267	15	72,837	15,600	12,000	22,000		
DTC-1212-QAB1	5,876.6	284	20	78,708	15,600	12,100	22,000		
DTC-1212-RAB1	6,126.7	296	25	82,918	15,800	12,200	22,200		
DTC-1212-SAB1	6,428.2	310	30	88,049	15,800	12,300	22,200		
DTC-1212-NAC1	5,665.3	273	10	64,714	17,300	13,500	24,000	15'-11 ⁷ / ₁₆ "	3'-5 ¹ / ₈ "
DTC-1212-PAC1	6,051.7	292	15	72,105	17,500	13,700	24,100		
DTC-1212-QAC1	6,486.9	313	20	78,132	17,500	13,700	24,100		
DTC-1212-RAC1	6,839.3	330	25	82,430	17,600	13,900	24,300		
DTC-1212-SAC1	7,184.2	347	30	87,659	17,700	13,900	24,300		
DTC-1212-NAD1	5,996.5	289	10	63,790	19,200	12,200	26,100	16'-8 ⁷ / ₁₆ "	4'-2 ¹ / ₂ "
DTC-1212-PAD1	6,501.3	314	15	71,351	19,300	12,200	26,200		
DTC-1212-QAD1	6,935.8	335	20	77,544	19,400	12,200	26,200		
DTC-1212-RAD1	7,256.7	350	25	81,934	19,500	12,200	26,400		
DTC-1212-SAD1	7,703.3	372	30	87,269	19,600	12,200	26,400		
DTC-1212-PAJ1	6,564.8	317	15	69,672	20,600	13,200	27,500	17'-5 ⁷ / ₁₆ "	4'-11 ¹ / ₈ "
DTC-1212-QAJ1	7,025.8	339	20	76,347	20,600	13,200	27,500		
DTC-1212-RAJ1	7,419.6	358	25	81,130	20,800	13,200	27,700		
DTC-1212-SAJ1	7,846.3	379	30	87,004	20,800	13,200	27,700		
DTC-1212-TAJ1	8,290.0	400	40	92,310	20,900	13,200	27,800		
DTC-1212-PAE1	6,653.3	321	15	70,569	21,300	13,900	28,400	17'-5 ⁷ / ₁₆ "	4'-11 ¹ / ₈ "
DTC-1212-QAE1	7,086.5	342	20	76,939	21,400	13,900	28,400		
DTC-1212-RAE1	7,472.3	361	25	81,432	21,500	13,900	28,600		
DTC-1212-SAE1	7,850.9	379	30	86,883	21,600	13,900	28,600		
DTC-1212-PAK1	6,749.0	326	15	68,397	22,700	15,100	29,900		
DTC-1212-QAK1	7,288.8	352	20	75,302	22,800	15,100	29,900	17'-5 ⁷ / ₁₆ "	4'-11 ¹ / ₈ "
DTC-1212-RAK1	7,668.3	370	25	80,234	22,900	15,100	30,100		
DTC-1212-SAK1	8,020.6	387	30	86,317	23,000	15,100	30,100		
DTC-1212-TAK1	8,600.9	415	40	91,732	23,100	15,100	30,200		

Model	R717 Charge lb - note 3	Internal Coil Volume ft ³	Pump Motor hp	Recirculating Flow Rate gpm	Remote Sump Application		
					Approximate Operating Weight lb	Bottom Outlet Diameter	Volume gal
DTC-1212-NAB1	435	44	5	700	19,900	10"	380
DTC-1212-PAB1	435	44			20,000		
DTC-1212-QAB1	435	44			20,000		
DTC-1212-RAB1	435	44			20,200		
DTC-1212-SAB1	435	44			20,200		
DTC-1212-NAC1	537	54			22,000		
DTC-1212-PAC1	537	54			22,100		
DTC-1212-QAC1	537	54			22,100		
DTC-1212-RAC1	537	54			22,300		
DTC-1212-SAC1	537	54			22,300		
DTC-1212-NAD1	640	65			24,000		
DTC-1212-PAD1	640	65			24,100		
DTC-1212-QAD1	640	65			24,200		
DTC-1212-RAD1	640	65			24,300		
DTC-1212-SAD1	640	65			24,400		
DTC-1212-PAJ1	710	72			25,400		
DTC-1212-QAJ1	710	72			25,500		
DTC-1212-RAJ1	710	72			25,600		
DTC-1212-SAJ1	710	72			25,700		
DTC-1212-TAJ1	710	72			25,800		
DTC-1212-PAE1	743	75			26,300		
DTC-1212-QAE1	743	75			26,300		
DTC-1212-RAE1	743	75			26,500		
DTC-1212-SAE1	743	75			26,500		
DTC-1212-PAK1	825	83			27,800		
DTC-1212-QAK1	825	83	27,800				
DTC-1212-RAK1	825	83	28,000				
DTC-1212-SAK1	825	83	28,000				
DTC-1212-TAK1	825	83	28,100				

12' x 12' Single Cell

10' x 18' Single Cell

Use this data for preliminary layouts only. Obtain current drawing from your sales representative.

UPDATE™ web-based selection software, available at spxcooling.com/update provides Cube model recommendations based on customer's specific design requirements.

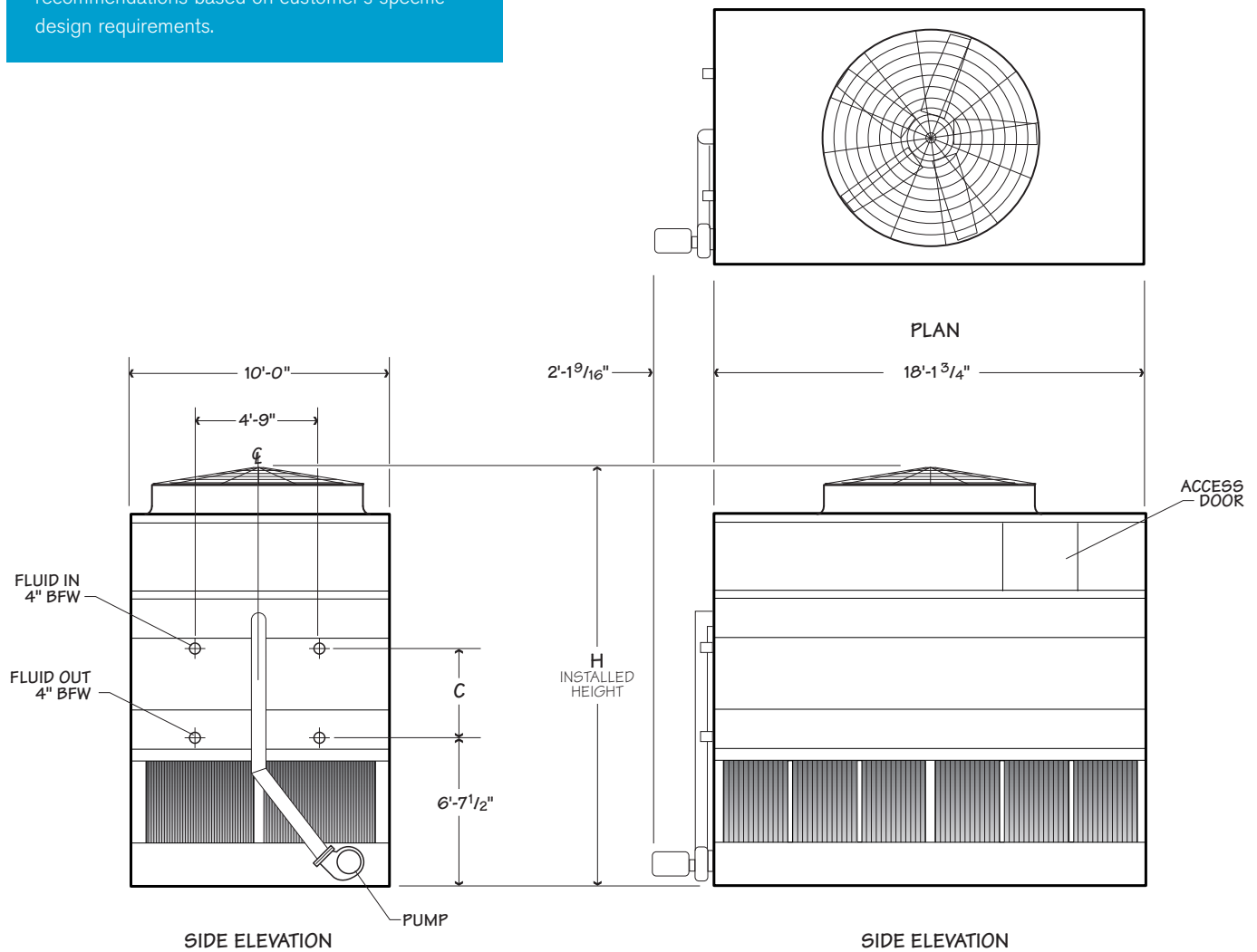

NOTE

1. The last digit of the model number shown represents the number of cells.
2. R717 tons are at 96.3°F condensing temperature, a 20°F suction temperature and a 78°F entering wet-bulb temperature.
3. For R134a charge, multiply by 1.98. For R22 charge multiply by 1.93. For R404A or R507A charge multiply by 1.65.
4. **Use this bulletin for preliminary layouts only.** Obtain current drawings from your sales representative.

Model note 1	Base Heat Rejection MBH	R717 Capacity tons - note 2	Fan Motor hp	Airflow Rate cfm	Shipping Weight lb		Design Operating Weight lb	Dimensions	
					Weight/Cell	Heaviest Section		H	C
DTC-1018-NAB1	6,108.2	295	10	72,775	19,000	15,400	26,600	16'-1 ⁹ / ₁₆ "	2'-8 ¹ / ₈ "
DTC-1018-PAB1	6,598.6	318	15	82,461	19,100	15,600	26,800		
DTC-1018-QAB1	6,994.6	337	20	89,996	19,100	15,600	26,800		
DTC-1018-RAB1	7,295.4	352	25	95,651	19,300	15,800	26,900		
DTC-1018-SAB1	7,682.1	371	30	101,695	19,300	15,800	27,000	16'-10 ⁹ / ₁₆ "	3'-5 ¹ / ₈ "
DTC-1018-NAC1	6,585.8	318	10	71,667	21,500	18,000	29,400		
DTC-1018-PAC1	7,179.6	346	15	81,483	21,600	18,100	29,500		
DTC-1018-QAC1	7,613.1	367	20	89,195	21,600	18,100	29,500		
DTC-1018-RAC1	7,979.4	385	25	94,960	21,800	18,300	29,700	17'-7 ⁹ / ₁₆ "	4'-2 ¹ / ₈ "
DTC-1018-SAC1	8,432.8	407	30	101,147	21,800	18,300	29,700		
DTC-1018-NAD1	6,949.0	335	10	70,538	23,800	16,900	31,900		
DTC-1018-PAD1	7,587.1	366	15	80,474	23,900	16,900	32,000		
DTC-1018-QAD1	8,122.2	392	20	88,371	23,900	16,900	32,000	17'-7 ⁹ / ₁₆ "	4'-2 ¹ / ₈ "
DTC-1018-RAD1	8,506.1	410	25	94,256	24,100	16,900	32,200		
DTC-1018-SAD1	8,997.8	434	30	100,600	24,100	16,900	32,200		
DTC-1018-TAD1	9,577.1	462	40	107,657	24,300	16,900	32,400		
DTC-1018-PAJ1	7,841.2	378	15	78,439	25,400	18,400	33,600	18'-4 ⁹ / ₁₆ "	4'-11 ¹ / ₈ "
DTC-1018-QAJ1	8,392.7	405	20	86,682	25,500	18,400	33,600		
DTC-1018-RAJ1	8,798.2	425	25	92,894	25,600	18,400	33,800		
DTC-1018-SAJ1	9,199.9	444	30	99,755	25,700	18,400	33,900		
DTC-1018-TAJ1	9,719.8	469	40	107,346	25,800	18,400	34,000	18'-4 ⁹ / ₁₆ "	4'-11 ¹ / ₈ "
DTC-1018-PAE1	7,946.9	383	15	79,438	26,400	19,300	34,700		
DTC-1018-QAE1	8,546.9	412	20	87,530	26,400	19,300	34,700		
DTC-1018-RAE1	8,965.4	433	25	93,539	26,500	19,300	34,800		
DTC-1018-SAE1	9,506.5	459	30	100,046	26,600	19,300	34,900	18'-4 ⁹ / ₁₆ "	4'-11 ¹ / ₈ "
DTC-1018-TAE1	10,118.7	488	40	107,189	26,700	19,300	35,000		
DTC-1018-PAK1	8,086.4	390	15	76,918	28,100	21,100	36,500		
DTC-1018-QAK1	8,725.5	421	20	85,348	28,100	21,100	36,600		
DTC-1018-RAK1	9,177.7	443	25	91,705	28,300	21,100	36,700	18'-4 ⁹ / ₁₆ "	4'-11 ¹ / ₈ "
DTC-1018-SAK1	9,668.9	467	30	98,811	28,300	21,100	36,800		
DTC-1018-TAK1	10,228.6	494	40	106,542	28,500	21,100	36,900		

Model	R717 Charge lb - note 3	Internal Coil Volume ft ³	Pump Motor hp	Recirculating Flow Rate gpm	Remote Sump Application		
					Approximate Operating Weight lb	Bottom Outlet Diameter	Volume gal
DTC-1018-NAB1	532	54	7.5	830	24,500	10"	480
DTC-1018-PAB1	532	54			24,700		
DTC-1018-QAB1	532	54			24,700		
DTC-1018-RAB1	532	54			24,900		
DTC-1018-SAB1	532	54			24,900		
DTC-1018-NAC1	660	67			27,300		
DTC-1018-PAC1	660	67			27,400		
DTC-1018-QAC1	660	67			27,400		
DTC-1018-RAC1	660	67			27,600		
DTC-1018-SAC1	660	67			27,600		
DTC-1018-NAD1	788	80			29,800		
DTC-1018-PAD1	788	80			29,900		
DTC-1018-QAD1	788	80			29,900		
DTC-1018-RAD1	788	80			30,100		
DTC-1018-SAD1	788	80			30,100		
DTC-1018-TAD1	788	80			30,300		
DTC-1018-PAJ1	876	89			31,500		
DTC-1018-QAJ1	876	89			31,600		
DTC-1018-RAJ1	876	89			31,700		
DTC-1018-SAJ1	876	89			31,800		
DTC-1018-TAJ1	876	89			31,900		
DTC-1018-PAE1	916	93			32,600		
DTC-1018-QAE1	916	93			32,600		
DTC-1018-RAE1	916	93			32,800		
DTC-1018-SAE1	916	93			32,800		
DTC-1018-TAE1	916	93			32,900		
DTC-1018-PAK1	1,019	103			34,400		
DTC-1018-QAK1	1,019	103			34,500		
DTC-1018-RAK1	1,019	103			34,600		
DTC-1018-SAK1	1,019	103			34,700		
DTC-1018-TAK1	1,019	103			34,800		

10' x 18' Single Cell

12' x 18' Single Cell

Use this data for preliminary layouts only. Obtain current drawing from your sales representative.

UPDATE™ web-based selection software, available at spxcooling.com/update provides Cube model recommendations based on customer's specific design requirements.

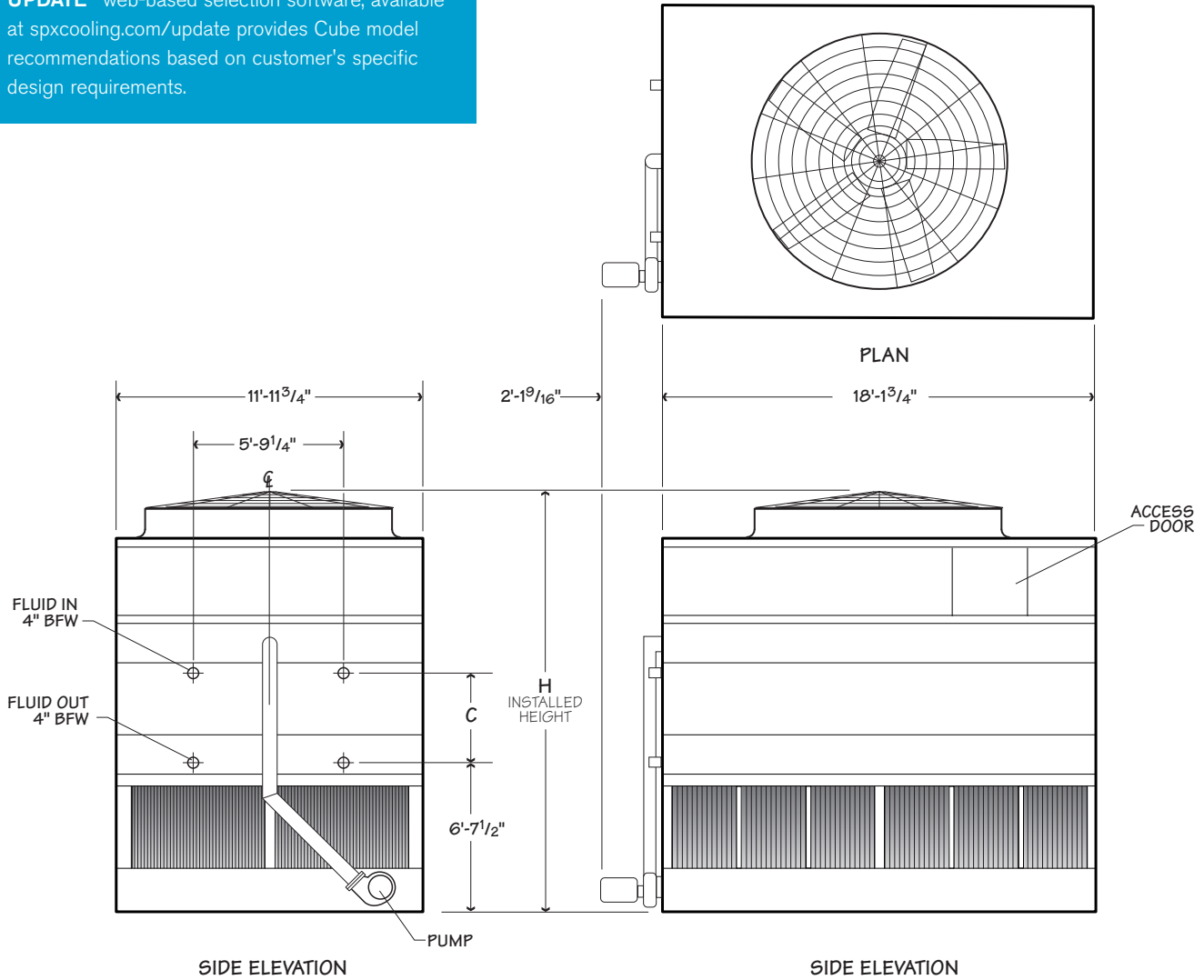

NOTE

1. The last digit of the model number shown represents the number of cells.
2. R717 tons are at 96.3°F condensing temperature, a 20°F suction temperature and a 78°F entering wet-bulb temperature.
3. For R134a charge, multiply by 1.98. For R22 charge multiply by 1.93. For R404A or R507A charge multiply by 1.65.
4. **Use this bulletin for preliminary layouts only.** Obtain current drawings from your sales representative.

Model note 1	Base Heat Rejection MBH	R717 Capacity tons - note 2	Fan Motor hp	Airflow Rate cfm	Shipping Weight lb		Design Operating Weight lb	Dimensions	
					Weight/Cell	Heaviest Section		H	C
DTC-1218-PAB1	7,689.0	371	15	97,107	22,000	16,500	31,600	16'-6 1/8"	2'-8 1/8"
DTC-1218-QAB1	8,207.1	396	20	105,969	22,100	16,600	31,600		
DTC-1218-RAB1	8,581.9	414	25	112,052	22,200	16,700	31,700		
DTC-1218-SAB1	8,980.7	433	30	118,598	22,300	16,800	31,800		
DTC-1218-PAC1	8,414.4	406	15	95,906	25,000	19,100	34,800	17'-3 1/8"	3'-5 1/8"
DTC-1218-QAC1	9,015.4	435	20	104,975	25,000	19,100	34,900		
DTC-1218-RAC1	9,492.1	458	25	111,173	25,200	19,300	35,000		
DTC-1218-SAC1	9,906.6	478	30	117,860	25,200	19,300	35,100		
DTC-1218-PAD1	8,953.2	432	15	94,670	27,800	17,400	37,900	18'-0 1/8"	4'-2 1/8"
DTC-1218-QAD1	9,649.1	466	20	103,955	27,800	17,400	37,900		
DTC-1218-RAD1	10,115.3	488	25	110,272	28,000	17,400	38,100		
DTC-1218-SAD1	10,549.0	509	30	117,109	28,000	17,400	38,200		
DTC-1218-TAD1	11,301.6	545	40	127,644	28,100	17,400	38,300		
DTC-1218-UAD1	12,207.0	589	50	134,124	28,100	17,400	38,300		
DTC-1218-OAJ1	9,881.8	477	20	101,943	29,600	19,000	39,900		
DTC-1218-RAJ1	10,300.3	497	25	108,555	29,800	19,000	40,000		
DTC-1218-SAJ1	10,851.4	524	30	115,863	29,800	19,000	40,100		
DTC-1218-TAJ1	11,523.1	556	40	127,195	29,900	19,000	40,200		
DTC-1218-UAJ1	12,029.1	580	50	134,215	30,000	19,000	40,200		
DTC-1218-VAJ1	12,517.9	604	60	139,374	30,300	19,000	40,600		
DTC-1218-OAE1	9,856.4	476	20	102,908	30,700	19,900	41,200	18'-9 1/8"	4'-11 1/8"
DTC-1218-RAE1	10,314.9	498	25	109,353	30,800	19,900	41,300		
DTC-1218-SAE1	10,821.9	522	30	116,351	30,900	19,900	41,400		
DTC-1218-TAE1	11,675.9	563	40	127,070	31,000	19,900	41,500		
DTC-1218-UAE1	12,224.2	590	50	133,623	31,000	19,900	41,500		
DTC-1218-OAK1	10,093.1	487	20	100,368	32,800	21,700	43,400		
DTC-1218-RAK1	11,085.6	535	25	112,853	33,000	21,700	43,600		
DTC-1218-SAK1	11,150.1	538	30	114,637	33,000	21,700	43,600		
DTC-1218-TAK1	11,979.1	578	40	126,266	33,100	21,700	43,700		
DTC-1218-UAK1	12,642.3	610	50	133,412	33,100	21,700	43,700		
DTC-1218-VAK1	13,181.1	636	60	139,048	33,500	21,700	44,100		

Model	R717 Charge lb - note 3	Internal Coil Volume ft³	Pump Motor hp	Recirculating Flow Rate gpm	Remote Sump Application		
					Approximate Operating Weight lb	Bottom Outlet Diameter	Volume gal
DTC-1218-PAB1	643	65	75	940	27,500	10"	570
DTC-1218-QAB1	643	65			27,600		
DTC-1218-RAB1	643	65			27,700		
DTC-1218-SAB1	643	65			27,800		
DTC-1218-PAC1	798	81			30,700		
DTC-1218-QAC1	798	81			30,700		
DTC-1218-RAC1	798	81			30,800		
DTC-1218-SAC1	798	81			30,900		
DTC-1218-PAD1	952	96			33,600		
DTC-1218-QAD1	952	96			33,600		
DTC-1218-RAD1	952	96			33,800		
DTC-1218-SAD1	952	96			33,800		
DTC-1218-TAD1	952	96			33,900		
DTC-1218-UAD1	952	96			33,900		
DTC-1218-OAJ1	1,059	107			35,400		
DTC-1218-RAJ1	1,059	107			35,600		
DTC-1218-SAJ1	1,059	107			35,600		
DTC-1218-TAJ1	1,059	107			35,800		
DTC-1218-UAJ1	1,059	107			35,800		
DTC-1218-VAJ1	1,059	107			36,200		
DTC-1218-OAE1	1,107	112			36,700		
DTC-1218-RAE1	1,107	112			36,900		
DTC-1218-SAE1	1,107	112			36,900		
DTC-1218-TAE1	1,107	112			37,000		
DTC-1218-UAE1	1,107	112			37,100		
DTC-1218-OAK1	1,231	125			38,900		
DTC-1218-RAK1	1,231	125			39,000		
DTC-1218-SAK1	1,231	125			39,100		
DTC-1218-TAK1	1,231	125			39,200		
DTC-1218-UAK1	1,231	125			39,200		
DTC-1218-VAK1	1,231	125			39,600		

12' x 18' Single Cell

8.5' x 18' Two Cell

Use this data for preliminary layouts only. Obtain current drawing from your sales representative.

UPDATE™ web-based selection software, available at spxcooling.com/update provides Cube model recommendations based on customer's specific design requirements.

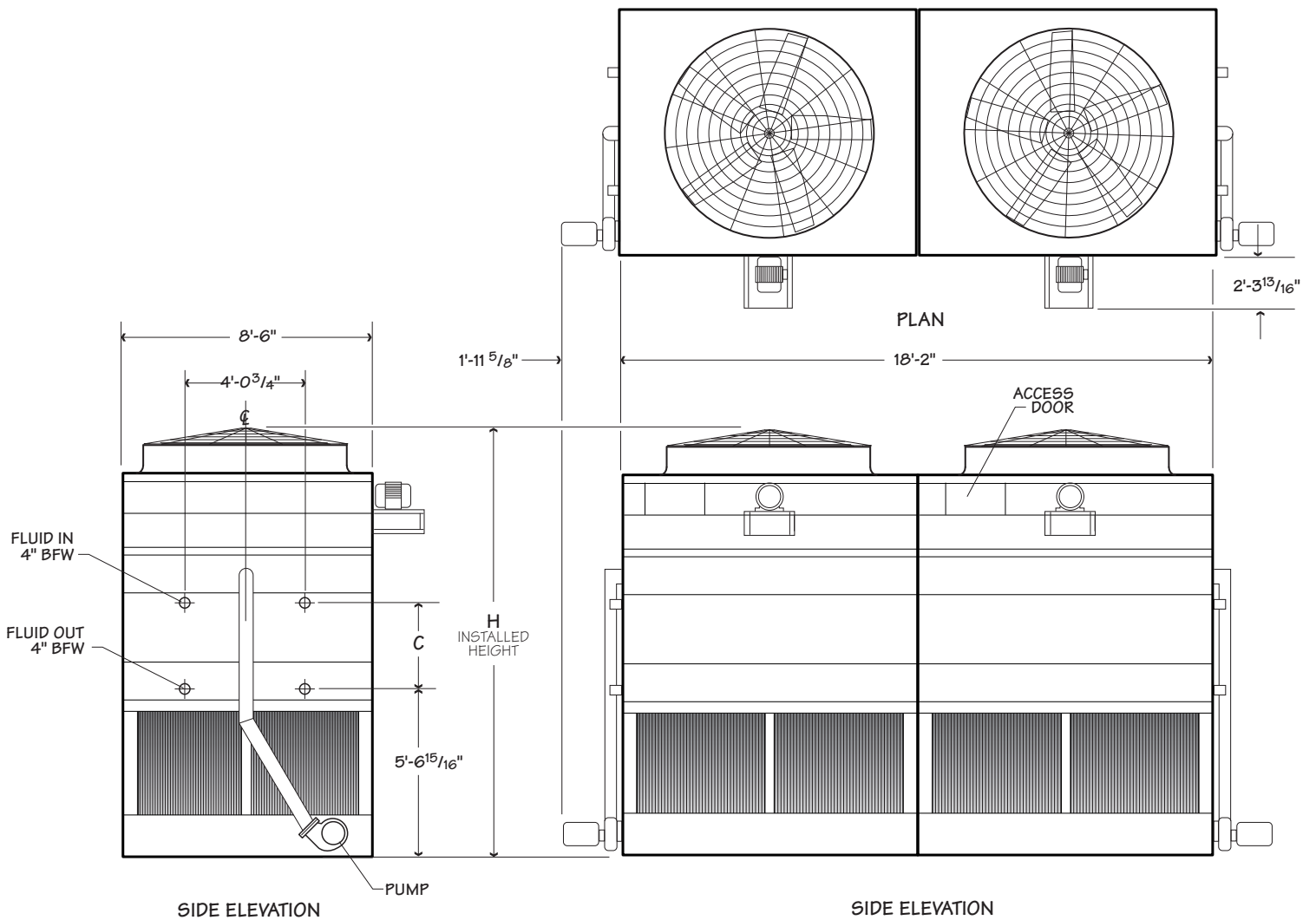

NOTE

1. The last digit of the model number shown represents the number of cells.
2. R717 tons are at 96.3°F condensing temperature, a 20°F suction temperature and a 78°F entering wet-bulb temperature.
3. For R134a charge, multiply by 1.98. For R22 charge multiply by 1.93. For R404A or R507A charge multiply by 1.65.
4. **Use this bulletin for preliminary layouts only.** Obtain current drawings from your sales representative.

Model note 1	Base Heat Rejection MBH	R717 Capacity tons - note 2	Fan Motor hp	Airflow Rate cfm	Shipping Weight lb		Design Operating Weight lb	Dimensions	
					Weight/Cell	Heaviest Section		H	C
DTC-8509-MAB2	5,618.6	271	2 x 7.5	78,748	9,100	7,600	23,400	13'-4 1/2"	2'-8 1/8"
DTC-8509-NAB2	5,937.8	287	2 x 10	84,634	9,100	7,600	23,600		
DTC-8509-PAB2	6,521.8	315	2 x 15	93,784	9,300	7,700	23,800		
DTC-8509-QAB2	6,802.8	328	2 x 20	97,524	9,300	7,700	23,800		
DTC-8509-MAC2	6,120.4	295	2 x 7.5	77,974	10,200	8,600	25,600	14'-1 1/2"	3'-5 1/8"
DTC-8509-NAC2	6,493.2	313	2 x 10	84,024	10,200	8,600	25,800		
DTC-8509-PAC2	7,144.8	345	2 x 15	93,358	10,300	8,700	26,000		
DTC-8509-QAC2	7,469.8	360	2 x 20	97,126	10,300	8,800	26,000		
DTC-8509-MAD2	6,497.0	313	2 x 7.5	77,172	11,200	9,600	27,800	14'-10 1/2"	4'-2 1/8"
DTC-8509-NAD2	6,913.4	334	2 x 10	83,400	11,200	9,700	27,800		
DTC-8509-PAD2	7,660.2	370	2 x 15	92,936	11,300	9,800	28,200		
DTC-8509-QAD2	7,978.0	385	2 x 20	96,734	11,400	9,800	28,200		
DTC-8509-MAJ2	6,658.0	321	2 x 7.5	75,158	11,800	10,300	29,200		
DTC-8509-NAJ2	7,056.0	340	2 x 10	81,918	11,900	10,300	29,200		
DTC-8509-PAJ2	7,737.8	373	2 x 15	92,268	12,000	10,400	29,400		
DTC-8509-QAJ2	8,059.2	389	2 x 20	96,598	12,000	10,400	29,600		
DTC-8509-MAE2	6,823.4	329	2 x 7.5	76,338	12,300	10,700	30,200		
DTC-8509-NAE2	7,290.2	352	2 x 10	82,760	12,300	10,800	30,200		
DTC-8509-PAE2	8,067.2	389	2 x 15	92,512	12,400	10,900	30,400	15'-7 1/2"	4'-11 1/8"
DTC-8509-QAE2	8,452.2	408	2 x 20	96,348	12,500	10,900	30,600		
DTC-8509-MAK2	6,923.8	334	2 x 7.5	73,772	13,000	11,500	31,800		
DTC-8509-NAK2	7,389.0	357	2 x 10	80,792	13,100	11,500	31,800		
DTC-8509-PAK2	8,158.2	394	2 x 15	91,522	13,200	11,600	32,000		
DTC-8509-QAK2	8,510.8	411	2 x 20	95,938	13,200	11,600	32,000		

Model	R717 Charge lb - note 3	Internal Coil Volume ft³	Pump Motor hp	Recirculating Flow Rate gpm	Remote Sump Application		
					Approximate Operating Weight lb	Bottom Outlet Diameter	Volume gal
DTC-8509-MAB2	454	46	2 x 2	710	22,000	2 x 8"	440
DTC-8509-NAB2	454	46			22,200		
DTC-8509-PAB2	454	46			22,400		
DTC-8509-QAB2	454	46			22,400		
DTC-8509-MAC2	454	46			24,200		
DTC-8509-NAC2	454	46			24,400		
DTC-8509-PAC2	454	46			24,600		
DTC-8509-QAC2	454	46			24,600		
DTC-8509-MAD2	672	68			26,400		
DTC-8509-NAD2	672	68			26,400		
DTC-8509-PAD2	672	68			26,800		
DTC-8509-QAD2	672	68			26,800		
DTC-8509-MAJ2	672	74			27,800		
DTC-8509-NAJ2	672	74			27,800		
DTC-8509-PAJ2	672	74			28,000		
DTC-8509-QAJ2	672	74			28,200		
DTC-8509-MAE2	770	78			28,800		
DTC-8509-NAE2	770	78			28,800		
DTC-8509-PAE2	770	78			29,000		
DTC-8509-QAE2	770	78			29,200		
DTC-8509-MAK2	850	86	30,400				
DTC-8509-NAK2	850	86	30,400				
DTC-8509-PAK2	850	86	30,600				
DTC-8509-QAK2	850	86	30,600				

8.5' x 18' Two Cell

8.5' x 24' Two Cell

Use this data for preliminary layouts only. Obtain current drawing from your sales representative.

UPDATE™ web-based selection software, available at spxcooling.com/update provides Cube model recommendations based on customer's specific design requirements.

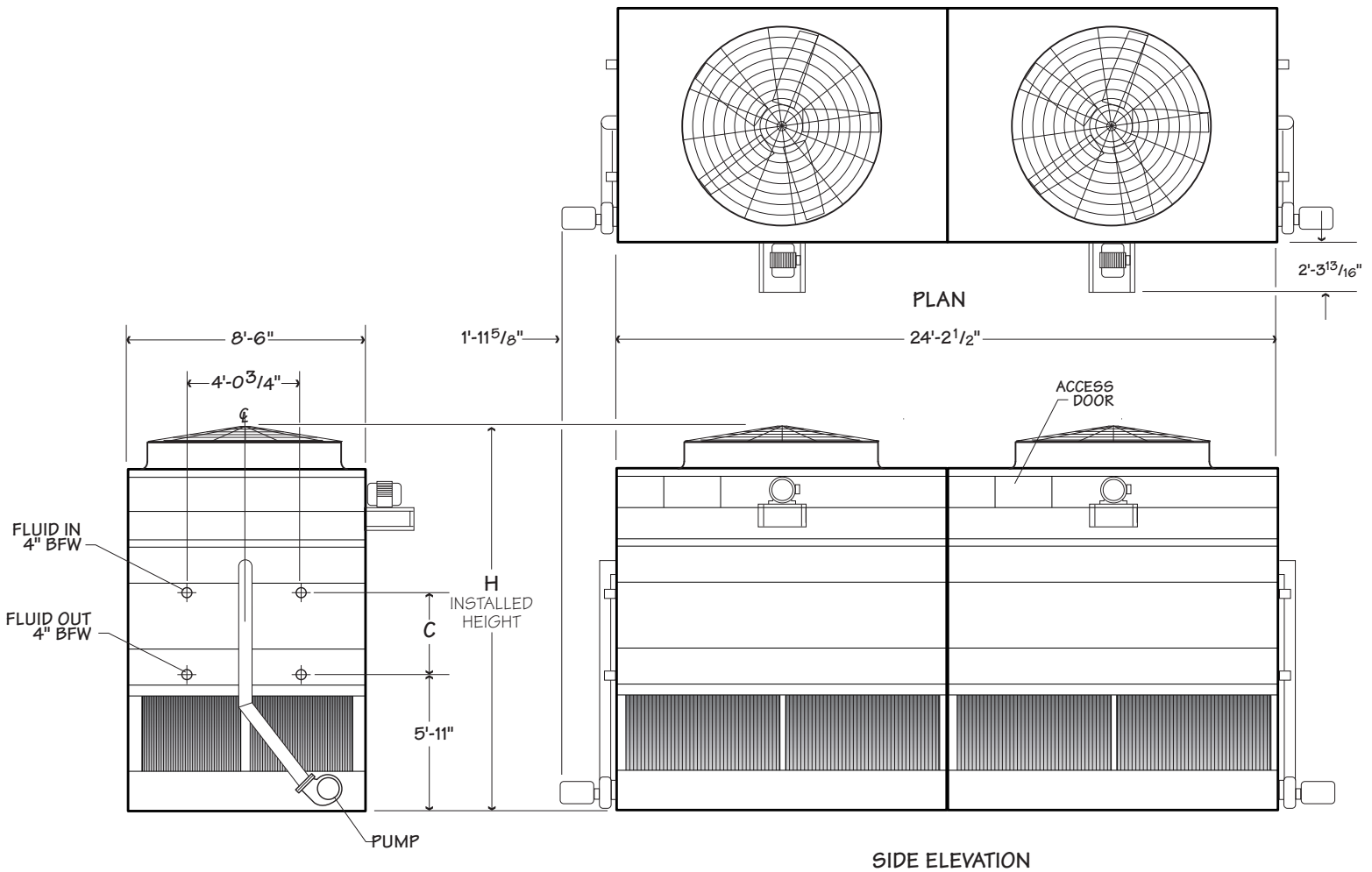

NOTE

1. The last digit of the model number shown represents the number of cells.
2. R717 tons are at 96.3°F condensing temperature, a 20°F suction temperature and a 78°F entering wet-bulb temperature.
3. For R134a charge, multiply by 1.98. For R22 charge multiply by 1.93. For R404A or R507A charge multiply by 1.65.
4. **Use this bulletin for preliminary layouts only.** Obtain current drawings from your sales representative.

Model note 1	Base Heat Rejection MBH	R717 Capacity tons - note 2	Fan Motor hp	Airflow Rate cfm	Shipping Weight lb		Design Operating Weight lb	Dimensions			
					Weight/Cell	Heaviest Section		H	C		
DTC-8512-NAB2	7,664.8	370	2 x 10	102,463	10,900	9,000	28,800	13'-8 1/2"	2'-8 1/8"		
DTC-8512-PAB2	8,428.6	407	2 x 15	114,863	11,000	9,100	29,000				
DTC-8512-OAB2	8,877.0	428	2 x 20	121,426	11,000	9,100	29,200				
DTC-8512-RAB2	9,176.8	443	2 x 25	125,356	11,200	9,300	29,400				
DTC-8512-NAC2	8,427.4	407	2 x 10	101,566	12,200	10,300	31,600	14'-5 1/2"	3'-5 1/8"		
DTC-8512-PAC2	9,250.8	446	2 x 15	114,264	12,300	10,400	31,800				
DTC-8512-OAC2	9,756.0	471	2 x 20	120,906	12,400	10,500	32,000				
DTC-8512-RAC2	10,092.6	487	2 x 25	124,872	12,500	10,600	32,200				
DTC-8512-NAD2	8,965.2	433	2 x 10	100,640	13,500	11,600	34,400	15'-2 1/2"	4'-2 1/8"		
DTC-8512-PAD2	9,904.6	478	2 x 15	113,658	13,700	11,800	34,600				
DTC-8512-OAD2	10,493.6	506	2 x 20	120,378	13,700	11,800	34,800				
DTC-8512-RAD2	10,844.4	523	2 x 25	124,384	13,900	12,000	35,000				
DTC-8512-SAD2	11,090.6	535	2 x 30	127,118	13,900	12,000	35,200				
DTC-8512-NAJ2	9,158.8	442	2 x 10	99,420	14,400	12,500	36,200				
DTC-8512-PAJ2	9,985.8	482	2 x 15	112,118	14,500	12,600	36,400				
DTC-8512-QAJ2	10,498.6	507	2 x 20	119,328	14,500	12,600	36,400				
DTC-8512-RAJ2	10,860.2	524	2 x 25	123,678	14,700	12,800	36,800				
DTC-8512-SAJ2	11,054.0	533	2 x 30	126,670	14,700	12,800	36,800				
DTC-8512-NAE2	9,424.2	455	2 x 10	99,676	14,900	13,000	37,400			15'-11 1/2"	4'-11 1/8"
DTC-8512-PAE2	10,423.2	503	2 x 15	113,036	15,100	13,200	37,600				
DTC-8512-OAE2	11,019.4	532	2 x 20	119,846	15,100	13,200	37,600				
DTC-8512-RAE2	11,401.0	550	2 x 25	123,896	15,300	13,400	38,000				
DTC-8512-SAE2	11,773.0	568	2 x 30	127,388	15,300	13,400	38,000				
DTC-8512-NAK2	9,478.2	457	2 x 10	96,522	15,900	14,000	39,400				
DTC-8512-PAK2	10,523.6	508	2 x 15	110,968	16,000	14,100	39,600				
DTC-8512-OAK2	11,065.8	534	2 x 20	118,316	16,000	14,100	39,600				
DTC-8512-RAK2	11,416.4	551	2 x 25	122,750	16,200	14,300	40,000				
DTC-8512-SAK2	11,650.4	562	2 x 30	125,798	16,200	14,300	40,000				

Model	R717 Charge lb - note 3	Internal Coil Volume ft³	Pump Motor hp	Recirculating Flow Rate gpm	Remote Sump Application		
					Approximate Operating Weight lb	Bottom Outlet Diameter	Volume gal
DTC-8512-NAB2	612	62	2 x 3	1,060	26,600	2 x 8"	540
DTC-8512-PAB2	612	62			26,800		
DTC-8512-OAB2	612	62			27,000		
DTC-8512-RAB2	612	62			27,200		
DTC-8512-NAC2	752	76			29,400		
DTC-8512-PAC2	752	76			29,600		
DTC-8512-OAC2	752	76			29,800		
DTC-8512-RAC2	752	76			30,000		
DTC-8512-NAD2	890	90			32,200		
DTC-8512-PAD2	890	90			32,400		
DTC-8512-OAD2	890	90			32,600		
DTC-8512-RAD2	890	90			32,800		
DTC-8512-SAD2	890	90			33,000		
DTC-8512-NAJ2	988	100			34,000		
DTC-8512-PAJ2	988	100			34,200		
DTC-8512-QAJ2	988	100			34,200		
DTC-8512-RAJ2	988	100			34,600		
DTC-8512-SAJ2	988	100			34,600		
DTC-8512-NAE2	1,028	104			35,200		
DTC-8512-PAE2	1,028	104			35,400		
DTC-8512-OAE2	1,028	104			35,400		
DTC-8512-RAE2	1,028	104			35,800		
DTC-8512-SAE2	1,028	104			35,800		
DTC-8512-NAK2	1,146	116			37,200		
DTC-8512-PAK2	1,146	116			37,400		
DTC-8512-OAK2	1,146	116			37,400		
DTC-8512-RAK2	1,146	116			37,800		
DTC-8512-SAK2	1,146	116			37,800		

8.5' x 24' Two Cell

10' x 24' Two Cell

Use this data for preliminary layouts only. Obtain current drawing from your sales representative.

UPDATE™ web-based selection software, available at spxcooling.com/update provides Cube model recommendations based on customer's specific design requirements.

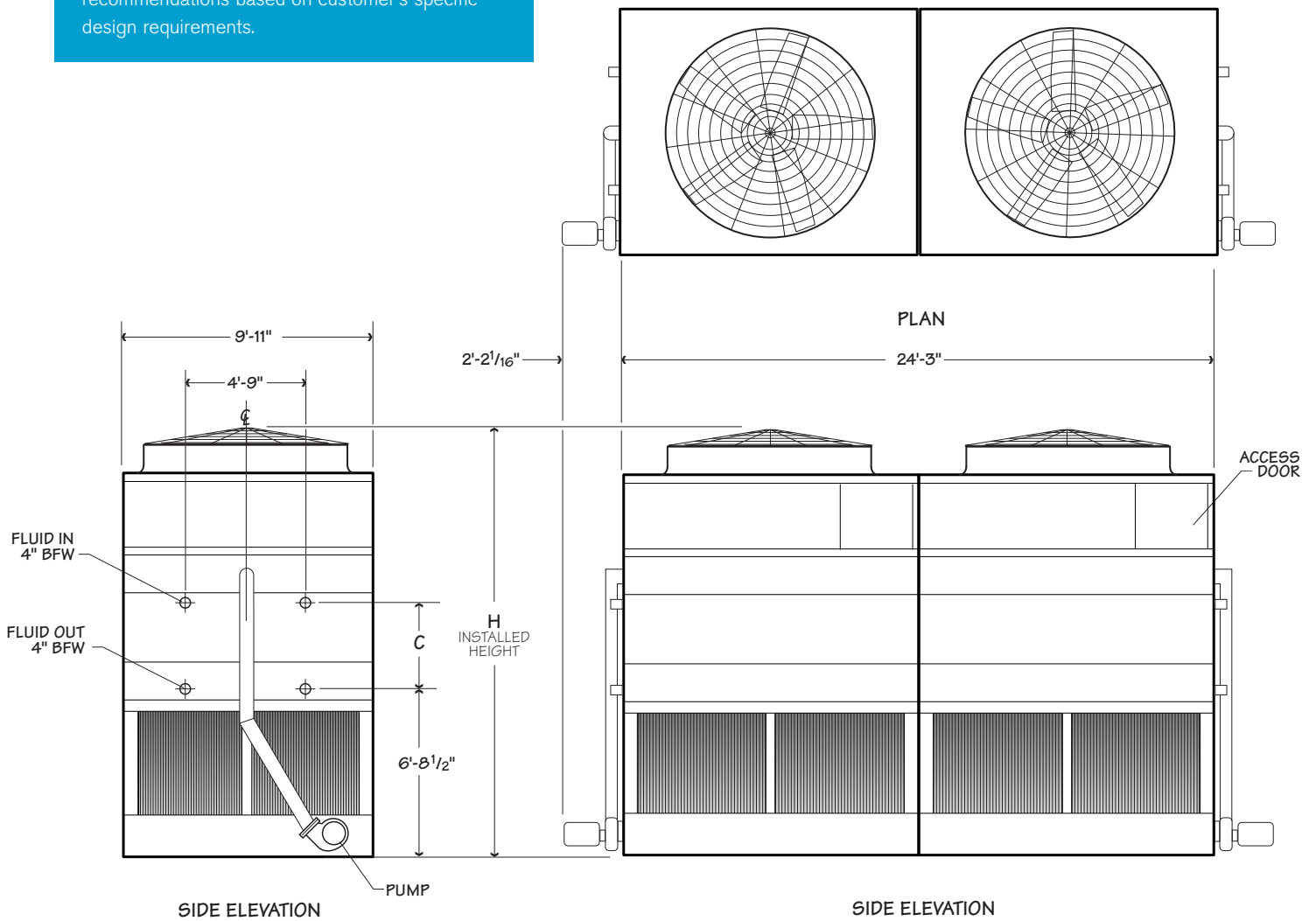

NOTE

1. The last digit of the model number shown represents the number of cells.
2. R717 tons are at 96.3°F condensing temperature, a 20°F suction temperature and a 78°F entering wet-bulb temperature.
3. For R134a charge, multiply by 1.98. For R22 charge multiply by 1.93. For R404A or R507A charge multiply by 1.65.
4. **Use this bulletin for preliminary layouts only.** Obtain current drawings from your sales representative.

Model note 1	Base Heat Rejection MBH	R717 Capacity tons - note 2	Fan Motor hp	Airflow Rate cfm	Shipping Weight lb		Design Operating Weight lb	Dimensions			
					Weight/Cell	Heaviest Section		H	C		
DTC-1012-NAB2	8,455.8	408	2 x 10	111,328	13,750	11,400	37,900	16'-2 ⁹ / ₁₆ "	2'-8 ¹ / ₈ "		
DTC-1012-PAB2	9,284.8	448	2 x 15	122,076	13,850	11,500	38,200				
DTC-1012-QAB2	9,861.6	476	2 x 20	131,628	13,900	11,500	38,200				
DTC-1012-RAB2	10,257.0	495	2 x 25	138,258	14,050	11,700	38,500				
DTC-1012-NAC2	9,523.0	459	2 x 10	109,898	15,300	13,000	41,400	16'-11 ⁹ / ₁₆ "	3'-5 ¹ / ₈ "		
DTC-1012-PAC2	10,196.7	492	2 x 15	120,926	15,450	13,100	41,600				
DTC-1012-QAC2	10,901.4	526	2 x 20	130,756	15,450	13,100	41,700				
DTC-1012-RAC2	11,523.1	556	2 x 25	137,536	15,650	13,300	42,000				
DTC-1012-NAD2	9,823.7	474	2 x 10	108,404	16,900	11,800	44,800	17'-8 ⁹ / ₁₆ "	4'-2 ¹ / ₈ "		
DTC-1012-PAD2	10,636.6	513	2 x 15	119,732	17,050	11,800	45,100				
DTC-1012-QAD2	11,349.9	548	2 x 20	129,850	17,050	11,800	45,100				
DTC-1012-RAD2	12,269.2	592	2 x 25	136,796	17,200	11,800	45,500				
DTC-1012-SAD2	12,945.2	625	2 x 30	146,282	17,250	11,800	45,600				
DTC-1012-NAJ2	10,384.2	501	2 x 10	105,048	17,950	12,800	47,000				
DTC-1012-PAJ2	11,183.6	540	2 x 15	116,890	18,050	12,800	47,300				
DTC-1012-QAJ2	11,919.8	575	2 x 20	127,880	18,100	12,800	47,300				
DTC-1012-RAJ2	12,424.7	600	2 x 25	135,488	18,250	12,800	47,600				
DTC-1012-SAJ2	13,098.2	632	2 x 30	145,972	18,300	12,800	47,700				
DTC-1012-PAE2	11,469.4	553	2 x 15	118,486	18,700	13,400	48,700			18'-5 ⁹ / ₁₆ "	4'-11 ¹ / ₈ "
DTC-1012-QAE2	12,291.8	593	2 x 20	128,918	18,750	13,400	48,800				
DTC-1012-RAE2	12,903.4	623	2 x 25	136,034	18,900	13,400	49,100				
DTC-1012-SAE2	13,408.4	647	2 x 30	145,726	18,950	13,400	49,200				
DTC-1012-PAK2	11,674.7	563	2 x 15	114,718	19,900	14,600	51,200				
DTC-1012-QAK2	12,484.7	602	2 x 20	126,116	19,900	14,600	51,300				
DTC-1012-RAK2	13,072.2	631	2 x 25	133,992	20,100	14,600	51,600				
DTC-1012-SAK2	13,554.2	654	2 x 30	144,850	20,100	14,600	51,700				

Model	R717 Charge lb - note 3	Internal Coil Volume ft ³	Pump Motor hp	Recirculating Flow Rate gpm	Remote Sump Application		
					Approximate Operating Weight lb	Bottom Outlet Diameter	Volume gal
DTC-1012-NAB2	719	73	2 x 5	1,200	35,500	2 x 8"	680
DTC-1012-PAB2	719	73			35,700		
DTC-1012-QAB2	719	73			35,800		
DTC-1012-RAB2	719	73			36,100		
DTC-1012-NAC2	889	90			38,900		
DTC-1012-PAC2	889	90			39,200		
DTC-1012-QAC2	889	90			39,200		
DTC-1012-RAC2	889	90			39,600		
DTC-1012-NAD2	1,059	107			42,400		
DTC-1012-PAD2	1,059	107			42,600		
DTC-1012-QAD2	1,059	107			42,700		
DTC-1012-RAD2	1,059	107			43,000		
DTC-1012-SAD2	1,059	107			43,100		
DTC-1012-NAJ2	1,176	119			44,600		
DTC-1012-PAJ2	1,176	119			44,800		
DTC-1012-QAJ2	1,176	119			44,900		
DTC-1012-RAJ2	1,176	119			45,200		
DTC-1012-SAJ2	1,176	119			45,300		
DTC-1012-PAE2	1,228	124			46,300		
DTC-1012-QAE2	1,228	124			46,300		
DTC-1012-RAE2	1,228	124			46,600		
DTC-1012-SAE2	1,228	124			46,700		
DTC-1012-PAK2	1,365	138			48,800		
DTC-1012-QAK2	1,365	138			48,800		
DTC-1012-RAK2	1,365	138			49,200		
DTC-1012-SAK2	1,365	138			49,200		

10' x 24' Two Cell

12' x 24' Two Cell

Use this data for preliminary layouts only. Obtain current drawing from your sales representative.

UPDATE™ web-based selection software, available at spxcooling.com/update provides Cube model recommendations based on customer's specific design requirements.

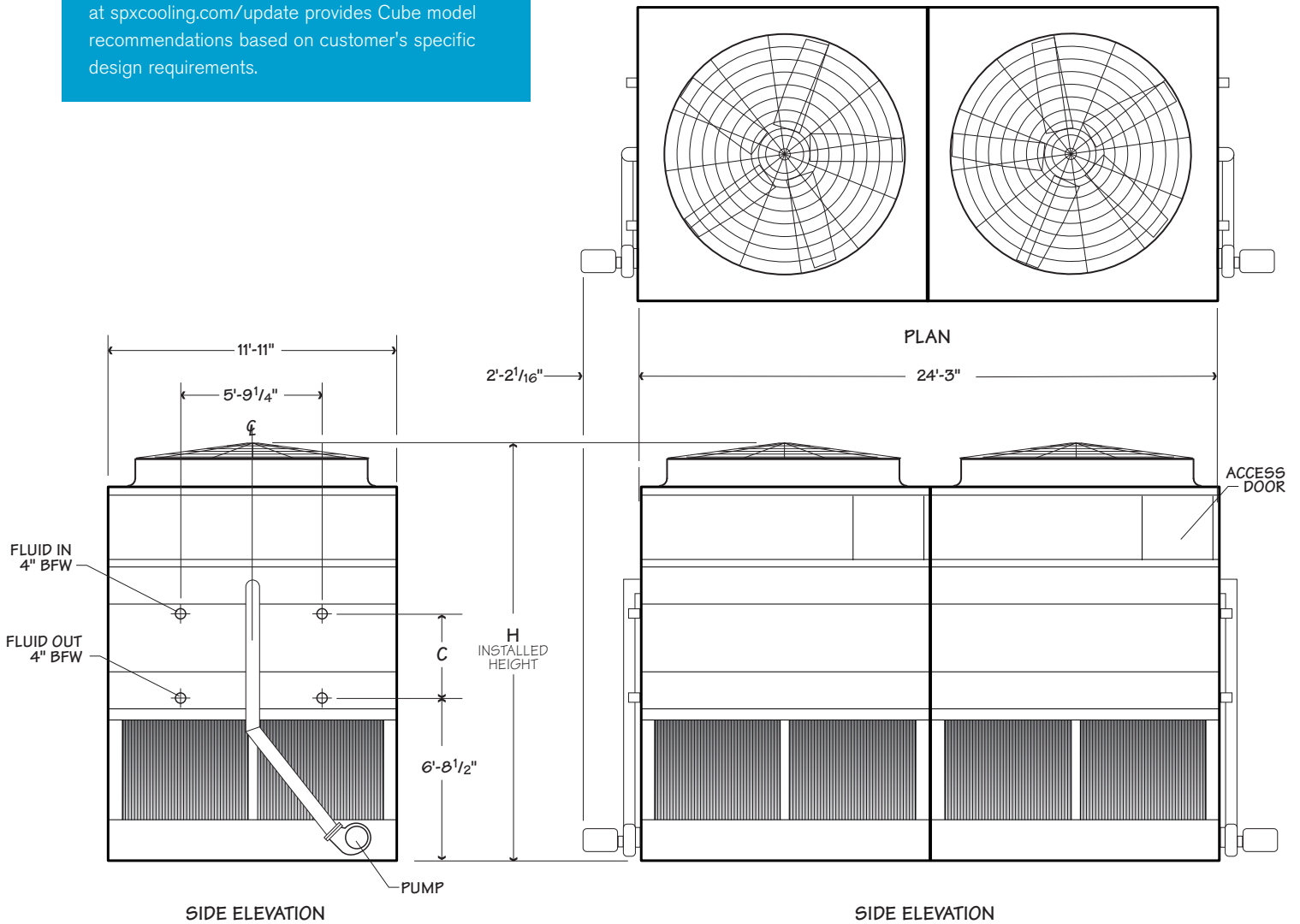

NOTE

1. The last digit of the model number shown represents the number of cells.
2. R717 tons are at 96.3°F condensing temperature, a 20°F suction temperature and a 78°F entering wet-bulb temperature.
3. For R134a charge, multiply by 1.98. For R22 charge multiply by 1.93. For R404A or R507A charge multiply by 1.65.
4. **Use this bulletin for preliminary layouts only.** Obtain current drawings from your sales representative.

Model note 1	Base Heat Rejection MBH	R717 Capacity tons - note 2	Fan Motor hp	Airflow Rate cfm	Shipping Weight lb		Design Operating Weight lb	Dimensions	
					Weight/Cell	Heaviest Section		H	C
DTC-1212-NAB2	10,051.6	485	2 x 10	131,208	15,600	13,100	43,200	16'-2 ⁹ / ₁₆ "	2'-8 ¹ / ₈ "
DTC-1212-PAB2	11,046.4	533	2 x 15	145,674	15,700	13,200	43,500		
DTC-1212-QAB2	11,753.2	567	2 x 20	157,416	15,750	13,200	43,500		
DTC-1212-RAB2	12,253.5	591	2 x 25	165,836	15,900	13,400	43,900		
DTC-1212-SAB2	12,856.4	620	2 x 30	176,098	15,950	13,400	43,900		
DTC-1212-NAC2	11,330.6	547	2 x 10	129,428	17,500	14,900	47,400	16'-11 ¹ / ₁₆ "	3'-5 ¹ / ₈ "
DTC-1212-PAC2	12,103.4	584	2 x 15	144,210	17,600	15,100	47,600		
DTC-1212-QAC2	12,973.9	626	2 x 20	156,264	17,650	15,100	47,700		
DTC-1212-RAC2	13,678.5	660	2 x 25	164,860	17,800	15,300	48,000		
DTC-1212-SAC2	14,368.4	693	2 x 30	175,318	17,850	15,300	48,100		
DTC-1212-NAD2	11,992.9	579	2 x 10	127,580	19,350	13,800	51,500	17'-8 ⁹ / ₁₆ "	4'-2 ¹ / ₂ "
DTC-1212-PAD2	13,002.7	627	2 x 15	142,702	19,500	13,800	51,700		
DTC-1212-QAD2	13,871.6	669	2 x 20	155,088	19,500	13,800	51,800		
DTC-1212-RAD2	14,513.5	700	2 x 25	163,868	19,700	13,800	52,100		
DTC-1212-SAD2	15,406.5	743	2 x 30	174,538	19,700	13,800	52,200		
DTC-1212-PAJ2	13,129.5	634	2 x 15	139,344	20,700	15,100	54,300	18'-8 ⁹ / ₁₆ "	4'-11 ¹ / ₈ "
DTC-1212-QAJ2	14,051.6	678	2 x 20	152,695	20,750	15,100	54,400		
DTC-1212-RAJ2	14,839.1	716	2 x 25	162,260	20,900	15,100	54,700		
DTC-1212-SAJ2	15,692.6	757	2 x 30	174,008	20,950	15,100	54,800		
DTC-1212-TAJ2	16,580.0	800	2 x 40	184,620	21,050	15,100	55,000		
DTC-1212-PAE2	13,306.6	642	2 x 15	141,138	21,450	15,800	56,000	18'-8 ⁹ / ₁₆ "	4'-11 ¹ / ₈ "
DTC-1212-QAE2	14,172.9	684	2 x 20	153,878	21,500	15,800	56,100		
DTC-1212-RAE2	14,944.5	721	2 x 25	162,864	21,650	15,800	56,400		
DTC-1212-SAE2	15,701.9	758	2 x 30	173,766	21,700	15,800	56,500		
DTC-1212-PAK2	13,497.9	651	2 x 15	136,794	22,900	17,200	59,000		
DTC-1212-QAK2	14,577.5	703	2 x 20	150,605	22,900	17,200	59,100	18'-8 ⁹ / ₁₆ "	4'-11 ¹ / ₈ "
DTC-1212-RAK2	15,336.5	740	2 x 25	160,469	23,100	17,200	59,400		
DTC-1212-SAK2	16,041.2	774	2 x 30	172,634	23,100	17,200	59,500		
DTC-1212-TAK2	17,201.8	830	2 x 40	183,465	23,250	17,200	59,700		

Model	R717 Charge lb - note 3	Internal Coil Volume ft ³	Pump Motor hp	Recirculating Flow Rate gpm	Remote Sump Application		
					Approximate Operating Weight lb	Bottom Outlet Diameter	Volume gal
DTC-1212-NAB2	870	88	2 x 5	1,400	40,100	2 x 10"	860
DTC-1212-PAB2	870	88			40,400		
DTC-1212-QAB2	870	88			40,400		
DTC-1212-RAB2	870	88			40,700		
DTC-1212-SAB2	870	88			40,800		
DTC-1212-NAC2	1,075	109			44,200		
DTC-1212-PAC2	1,075	109			44,500		
DTC-1212-QAC2	1,075	109			44,500		
DTC-1212-RAC2	1,075	109			44,900		
DTC-1212-SAC2	1,075	109			44,900		
DTC-1212-NAD2	1,280	130			48,400		
DTC-1212-PAD2	1,280	130			48,600		
DTC-1212-QAD2	1,280	130			48,700		
DTC-1212-RAD2	1,280	130			49,000		
DTC-1212-SAD2	1,280	130			49,100		
DTC-1212-PAJ2	1,421	144			51,200		
DTC-1212-QAJ2	1,421	144			51,300		
DTC-1212-RAJ2	1,421	144			51,600		
DTC-1212-SAJ2	1,421	144			51,700		
DTC-1212-TAJ2	1,421	144			51,900		
DTC-1212-PAE2	1,485	150			52,900		
DTC-1212-QAE2	1,485	150			52,900		
DTC-1212-RAE2	1,485	150			53,300		
DTC-1212-SAE2	1,485	150			53,300		
DTC-1212-PAK2	1,649	167			55,900		
DTC-1212-QAK2	1,649	167			55,900		
DTC-1212-RAK2	1,649	167			56,300		
DTC-1212-SAK2	1,649	167	56,300				
DTC-1212-TAK2	1,649	167	56,600				

12' x 24' Two Cell

10' x 36' Two Cell

Use this data for preliminary layouts only. Obtain current drawing from your sales representative.

UPDATE™ web-based selection software, available at spxcooling.com/update provides Cube model recommendations based on customer's specific design requirements.

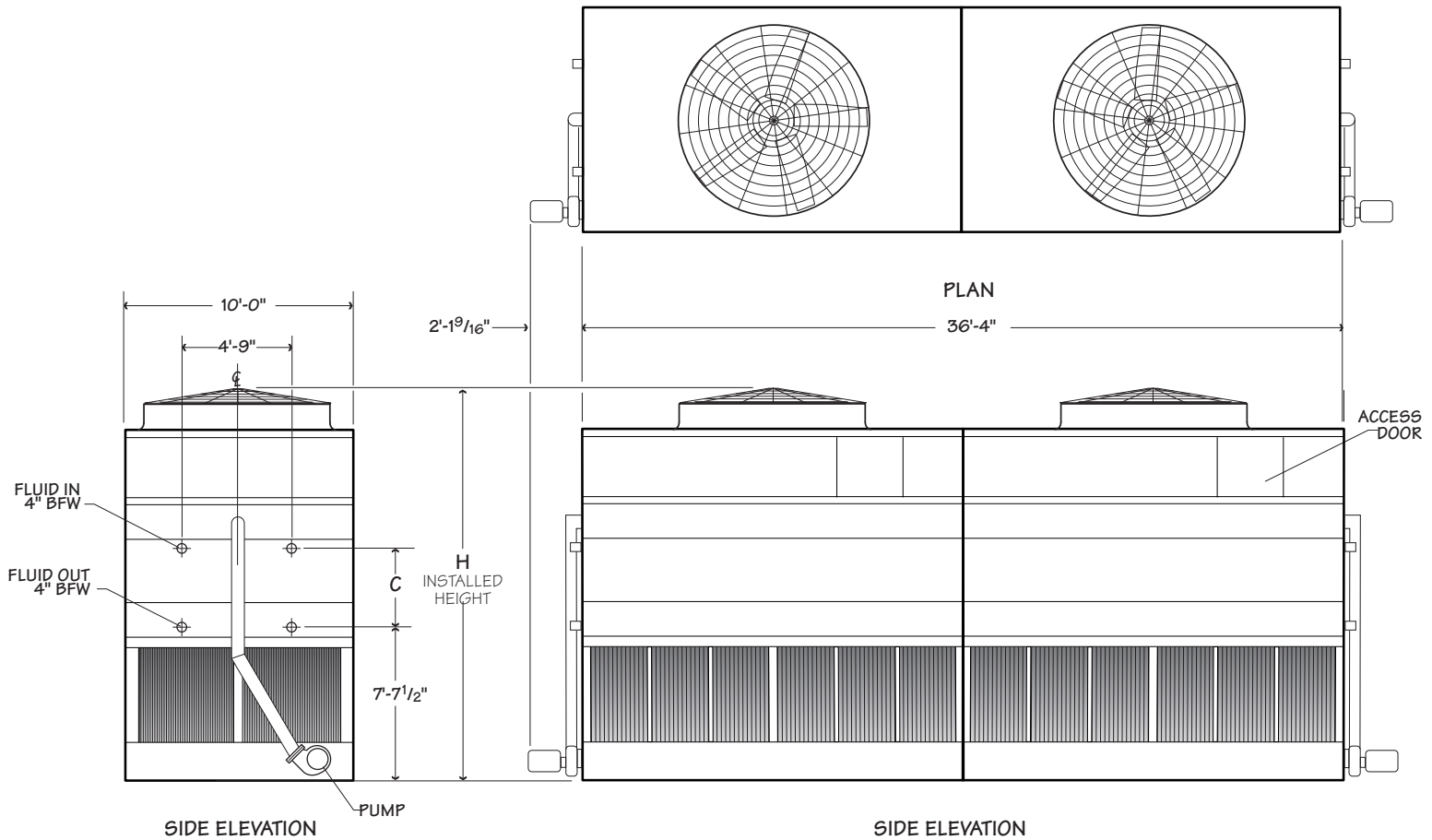

NOTE

1. The last digit of the model number shown represents the number of cells.
2. R717 tons are at 96.3°F condensing temperature, a 20°F suction temperature and a 78°F entering wet-bulb temperature.
3. For R134a charge, multiply by 1.98. For R22 charge multiply by 1.93. For R404A or R507A charge multiply by 1.65.
4. **Use this bulletin for preliminary layouts only.** Obtain current drawings from your sales representative.

Model note 1	Base Heat Rejection MBH	R717 Capacity tons - note 2	Fan Motor hp	Airflow Rate cfm	Shipping Weight lb		Design Operating Weight lb	Dimensions	
					Weight/Cell	Heaviest Section		H	C
DTC-1018-NAB2	12,216.4	589	2 x10	145,550	19,200	15,400	53,800	17'-1 ⁹ / ₁₆ "	2'-8 ¹ / ₁₆ "
DTC-1018-PAB2	13,197.2	637	2 x15	164,922	19,300	15,600	54,000		
DTC-1018-OAB2	13,989.3	675	2 x20	179,992	19,350	15,600	54,100		
DTC-1018-RAB2	14,590.8	704	2 x25	191,302	19,500	15,800	54,400		
DTC-1018-SAB2	15,364.1	741	2 x30	203,390	19,550	15,800	54,500		
DTC-1018-NAC2	13,171.7	636	2 x10	143,334	21,700	18,000	59,200	17'-10 ⁹ / ₁₆ "	3'-5 ¹ / ₁₆ "
DTC-1018-PAC2	14,359.3	693	2 x15	162,966	21,800	18,100	59,500		
DTC-1018-OAC2	15,226.3	735	2 x20	178,890	21,850	18,100	59,500		
DTC-1018-RAC2	15,958.8	770	2 x25	189,920	22,000	18,300	59,800		
DTC-1018-SAC2	16,865.6	814	2 x30	202,294	22,050	18,300	59,900		
DTC-1018-NAD2	13,898.1	671	2 x10	141,076	24,000	16,900	64,300	18'-7 ⁹ / ₁₆ "	4'-2 ¹ / ₁₆ "
DTC-1018-PAD2	15,174.2	732	2 x15	160,948	24,150	16,900	64,500		
DTC-1018-OAD2	16,244.3	784	2 x20	176,742	24,150	16,900	64,600		
DTC-1018-RAD2	17,012.3	821	2 x25	188,512	24,300	16,900	64,900		
DTC-1018-SAD2	17,995.7	868	2 x30	201,200	24,350	16,900	65,000		
DTC-1018-TAD2	19,154.1	924	2 x40	215,314	24,500	16,900	65,200	19'-4 ⁹ / ₁₆ "	4'-11 ¹ / ₁₆ "
DTC-1018-PAJ2	15,682.3	757	2 x15	156,878	25,650	18,400	67,700		
DTC-1018-OAJ2	16,785.3	810	2 x20	173,364	25,700	18,400	67,800		
DTC-1018-RAJ2	17,596.3	849	2 x25	185,788	25,850	18,400	68,100		
DTC-1018-SAJ2	18,399.8	888	2 x30	199,510	25,900	18,400	68,200		
DTC-1018-TAJ2	19,439.6	938	2 x40	214,692	26,000	18,400	68,400	19'-4 ⁹ / ₁₆ "	4'-11 ¹ / ₁₆ "
DTC-1018-PAE2	15,893.8	767	2 x15	158,876	26,600	19,300	69,800		
DTC-1018-OAE2	17,093.9	825	2 x20	175,060	26,600	19,300	69,900		
DTC-1018-RAE2	17,930.7	865	2 x25	187,078	26,750	19,300	70,200		
DTC-1018-SAE2	19,012.9	917	2 x30	200,092	26,800	19,300	70,300		
DTC-1018-TAE2	20,237.3	976	2 x40	214,378	26,950	19,300	70,500	19'-4 ⁹ / ₁₆ "	4'-11 ¹ / ₁₆ "
DTC-1018-PAK2	16,172.8	780	2 x15	153,836	28,350	21,100	73,500		
DTC-1018-OAK2	17,451.1	842	2 x20	170,696	28,350	21,100	73,600		
DTC-1018-RAK2	18,355.4	886	2 x25	183,410	28,550	21,100	73,900		
DTC-1018-SAK2	19,337.8	933	2 x30	197,622	28,550	21,100	74,000		
DTC-1018-TAK2	20,457.2	987	2 x40	213,084	28,700	21,100	74,200		

Model	R717 Charge lb - note 3	Internal Coil Volume ft ³	Pump Motor hp	Recirculating Flow Rate gpm	Remote Sump Application		
					Approximate Operating Weight lb	Bottom Outlet Diameter	Volume gal
DTC-1018-NAB2	1,064	108	2 x 7.5	1,660	49,600	2 x10"	960
DTC-1018-PAB2	1,064	108			49,800		
DTC-1018-OAB2	1,064	108			49,900		
DTC-1018-RAB2	1,064	108			50,200		
DTC-1018-SAB2	1,064	108			50,300		
DTC-1018-NAC2	1,320	134			55,100		
DTC-1018-PAC2	1,320	134			55,300		
DTC-1018-OAC2	1,320	134			55,400		
DTC-1018-RAC2	1,320	134			55,700		
DTC-1018-SAC2	1,320	134			55,800		
DTC-1018-NAD2	1,575	159			60,100		
DTC-1018-PAD2	1,575	159			60,300		
DTC-1018-OAD2	1,575	159			60,400		
DTC-1018-RAD2	1,575	159			60,700		
DTC-1018-SAD2	1,575	159			60,800		
DTC-1018-TAD2	1,575	159			61,000		
DTC-1018-PAJ2	1,753	177			63,500		
DTC-1018-OAJ2	1,753	177			63,600		
DTC-1018-RAJ2	1,753	177			63,900		
DTC-1018-SAJ2	1,753	177			64,000		
DTC-1018-TAJ2	1,753	177			64,200		
DTC-1018-PAE2	1,831	185			65,600		
DTC-1018-OAE2	1,831	185			65,700		
DTC-1018-RAE2	1,831	185			66,000		
DTC-1018-SAE2	1,831	185			66,100		
DTC-1018-TAE2	1,831	185			66,300		
DTC-1018-PAK2	2,038	206			69,400		
DTC-1018-OAK2	2,038	206			69,400		
DTC-1018-RAK2	2,038	206			69,700		
DTC-1018-SAK2	2,038	206			69,800		
DTC-1018-TAK2	2,038	206			70,100		

10' x 36' Two Cell

12' x 36' Two Cell

Use this data for preliminary layouts only. Obtain current drawing from your sales representative.

UPDATE™ web-based selection software, available at spcooling.com/update provides Cube model recommendations based on customer's specific design requirements.

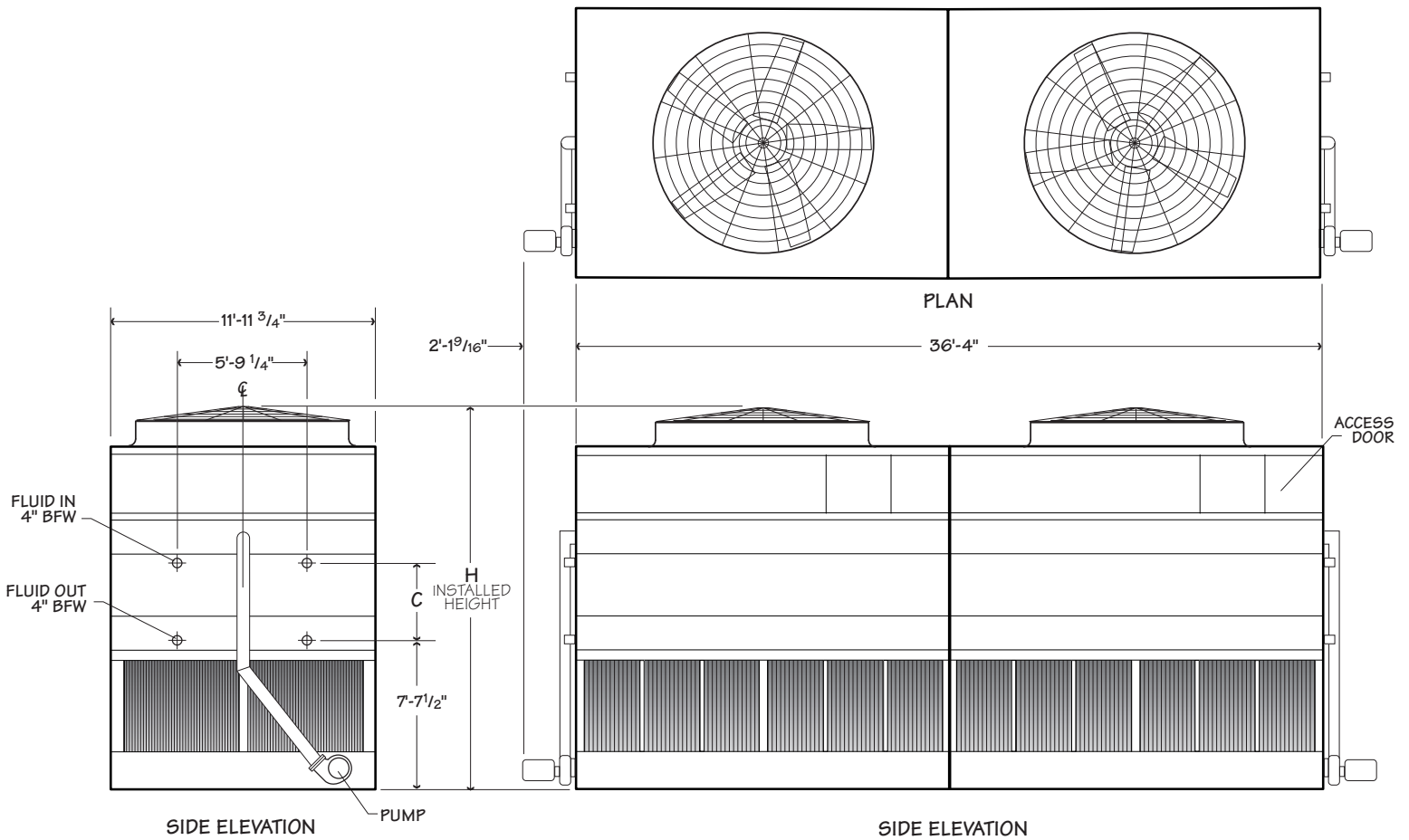

NOTE

1. The last digit of the model number shown represents the number of cells.
2. R717 tons are at 96.3°F condensing temperature, a 20°F suction temperature and a 78°F entering wet-bulb temperature.
3. For R134a charge, multiply by 1.98. For R22 charge multiply by 1.93. For R404A or R507A charge multiply by 1.65.
4. **Use this bulletin for preliminary layouts only.** Obtain current drawings from your sales representative.

Model note 1	Base Heat Rejection MBH	R717 Capacity tons - note 2	Fan Motor hp	Airflow Rate cfm	Shipping Weight lb		Design Operating Weight lb	Dimensions	
					Weight/Cell	Heaviest Section		H	C
DTC-1218-PAB2	15,378.0	742	2 x 15	194,214	22,300	18,200	60,200	17'-8 1/8"	2'-8 1/8"
DTC-1218-QAB2	16,414.2	792	2 x 20	211,938	22,300	18,200	60,200		
DTC-1218-RAB2	17,163.8	828	2 x 25	224,104	22,450	18,300	60,600		
DTC-1218-SAB2	17,961.3	867	2 x 30	237,196	22,500	18,400	60,600		
DTC-1218-PAC2	16,828.7	812	2 x 15	191,812	25,250	21,100	66,400	18'-3 1/8"	3'-5 1/8"
DTC-1218-QAC2	18,030.8	870	2 x 20	209,950	25,300	21,200	66,500		
DTC-1218-RAC2	18,984.1	916	2 x 25	222,346	25,450	21,300	66,800		
DTC-1218-SAC2	19,813.1	956	2 x 30	235,720	25,500	21,400	66,900		
DTC-1218-PAD2	17,906.4	864	2 x 15	189,340	28,000	19,900	72,300	19'-0 1/8"	4'-2 1/8"
DTC-1218-QAD2	19,298.1	931	2 x 20	207,910	28,050	19,900	72,300		
DTC-1218-RAD2	20,230.7	976	2 x 25	220,544	28,200	19,900	72,600		
DTC-1218-SAD2	21,098.1	1,018	2 x 30	234,218	28,250	19,900	72,700		
DTC-1218-TAD2	22,603.2	1,091	2 x 40	255,288	28,350	19,900	73,000		
DTC-1218-UAD2	24,414.1	1,178	2 x 0	268,248	28,400	19,900	73,000		
DTC-1218-OAJ2	19,763.7	954	2 x 20	203,886	29,850	21,700	76,000		
DTC-1218-RAJ2	20,600.7	994	2 x 25	217,110	30,000	21,700	76,300		
DTC-1218-SAJ2	21,702.9	1,047	2 x 30	231,726	30,050	21,700	76,400		
DTC-1218-TAJ2	23,046.2	1,112	2 x 40	254,390	30,150	21,700	76,600		
DTC-1218-UAJ2	24,058.3	1,161	2 x 50	268,430	30,200	21,700	76,700		
DTC-1218-VAJ2	25,035.8	1,208	2 x 60	278,748	30,550	21,700	77,400		
DTC-1218-OAE2	19,712.9	951	2 x 20	205,816	30,950	22,700	78,600	19'-9 1/8"	4'-11 1/8"
DTC-1218-RAE2	20,629.7	995	2 x 25	218,706	31,100	22,700	78,900		
DTC-1218-SAE2	21,643.8	1,044	2 x 30	232,702	31,150	22,700	79,000		
DTC-1218-TAE2	23,351.7	1,127	2 x 40	254,140	31,250	22,700	79,200		
DTC-1218-UAE2	24,448.3	1,180	2 x 50	267,246	31,300	22,700	79,300		
DTC-1218-OAK2	20,186.2	974	2 x 20	200,736	33,050	24,900	82,900		
DTC-1218-RAK2	22,171.1	1,070	2 x 25	225,706	33,200	24,900	83,200		
DTC-1218-SAK2	22,300.1	1,076	2 x 30	229,274	33,250	24,900	83,300		
DTC-1218-TAK2	23,958.1	1,156	2 x 40	252,532	33,350	24,900	83,500		
DTC-1218-UAK2	25,284.5	1,220	2 x 50	266,824	33,400	24,900	83,600		
DTC-1218-VAK2	26,362.2	1,272	2 x 60	278,096	33,750	24,900	84,300		

Model	R717 Charge lb - note 3	Internal Coil Volume ft³	Pump Motor hp	Recirculating Flow Rate gpm	Remote Sump Application		
					Approximate Operating Weight lb	Bottom Outlet Diameter	Volume gal
DTC-1218-PAB2	1,286	130	2 x 75	1,880	55,600	2 x 10"	1,140
DTC-1218-QAB2	1,286	130			55,600		
DTC-1218-RAB2	1,286	130			55,900		
DTC-1218-SAB2	1,286	130			56,000		
DTC-1218-PAC2	1,596	162			61,800		
DTC-1218-QAC2	1,596	162			61,900		
DTC-1218-RAC2	1,596	162			62,200		
DTC-1218-SAC2	1,596	162			62,300		
DTC-1218-PAD2	1,905	193			67,600		
DTC-1218-QAD2	1,905	193			67,700		
DTC-1218-RAD2	1,905	193			68,000		
DTC-1218-SAD2	1,905	193			68,100		
DTC-1218-TAD2	1,905	193			68,300		
DTC-1218-UAD2	1,905	193			68,400		
DTC-1218-OAJ2	2,118	214			71,400		
DTC-1218-RAJ2	2,118	214			71,700		
DTC-1218-SAJ2	2,118	214			71,800		
DTC-1218-TAJ2	2,118	214			72,000		
DTC-1218-UAJ2	2,118	214			72,100		
DTC-1218-VAJ2	2,118	214			72,800		
DTC-1218-OAE2	2,214	224			74,000		
DTC-1218-RAE2	2,214	224			74,300		
DTC-1218-SAE2	2,214	224			74,400		
DTC-1218-TAE2	2,214	224			74,600		
DTC-1218-UAE2	2,214	224			74,600		
DTC-1218-OAK2	2,463	249			78,300		
DTC-1218-RAK2	2,463	249			78,600		
DTC-1218-SAK2	2,463	249			78,700		
DTC-1218-TAK2	2,463	249			78,900		
DTC-1218-UAK2	2,463	249			79,000		
DTC-1218-VAK2	2,463	249			79,700		

12' x 36' Two Cell

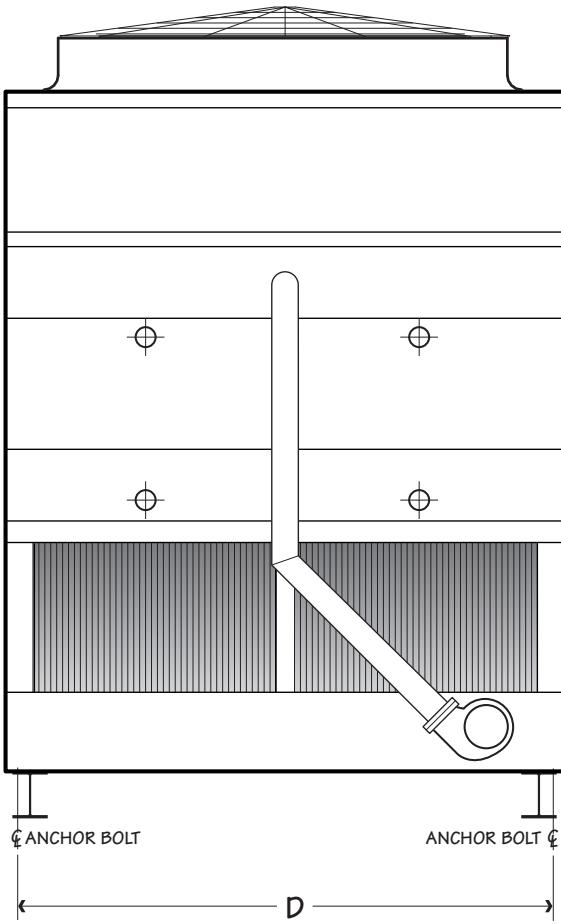

Model	D	Maximum Deflection
DTC-8509	8'-3 ⁷ / ₈ "	1/2"
DTC-8512	8'-3 ⁷ / ₈ "	1/2"
DTC-1012	9'-8 ¹ / ₈ "	1/2"
DTC-1018	9'-8 ¹ / ₈ "	1/2"
DTC-1212	11'-8 ³ / ₈ "	1/2"
DTC-1218	11'-8 ³ / ₈ "	1/2"

NOTE

1. The recommended supporting steel arrangement for the Cube DTC Evap Condenser consists of parallel I-beams running the full length of the unit.
2. Supporting steel is to be designed, constructed and furnished by others.
3. The top surface of the supporting steel must be framed flush and level.
4. If vibration isolators are used, they must be placed underneath the supporting steel beams.
5. Consider provisions for access to the condenser if the supporting steel is elevated above grade.
6. **Use this bulletin for preliminary layouts only.** Obtain current drawings from your sales representative.

The purpose of a basin heater is to prevent recirculating water from freezing in the collection basin during periods of shutdown or standby operation. Heater systems are sized according to tower model and ambient temperature to give maximum protection against freezing in the collection basin. They are not intended to protect the coil and other components from icing.

An automatic basin water heater system consists of the following components:

- Stainless steel electric immersion heater(s). Threaded couplings are provided in the side of the collection basin.
- NEMA 4 enclosure containing:
 - Transformer to convert power supply to 24 volts for control circuit.
 - Magnetic contactor to energize heater.
 - Solid state circuit board for temperature and low-water cutoff.
 - The enclosure may be mounted on the side of the condenser.
- Control probe in the collection basin to monitor water temperature and level.

Heater components are typically shipped separately for installation by others.

Heat trace and insulation of the pump may be optionally selected.

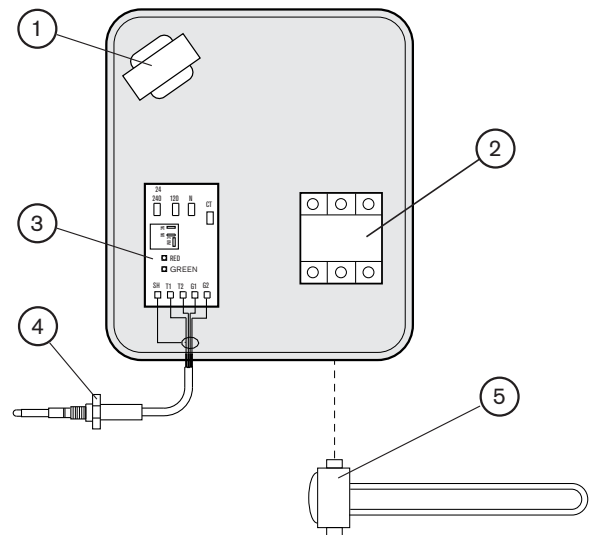

1. Transformer
2. Contactor
3. Solid State Relay Card
4. Sensor Probe
5. Heater Element(s)

Model	Heater Size kW		
	0°F Ambient	-20°F Ambient	-40°F Ambient
DTC-8509	6	7.5	12
DTC-8512	7.5	12	2 x 7.5
DTC-1012	9	12	2 x 7.5
DTC-1018	12	2 x 9	2 x 12
DTC-1212	12	2 x 7.5	2 x 9
DTC-1218	2 x 7.5	2 x 12	2 x 12

Condenser Recirculating Water

When the ambient air temperature falls below 32°F, the recirculating water within the condenser can freeze. *Marley Technical Report #H-003* “Cooling Towers and Freezing Weather” describes how to prevent freezing during operation. Ask your sales representative for a copy or download a copy at spxcooling.com. During shutdown, water collects in the basin and may freeze solid. You can prevent freezing by adding heat to the water left in the basin or, you can drain the condenser basin and all exposed pipework at shutdown.

Remote Sump Application

With this type of system, recirculating water used by the condenser for evaporative heat rejection is pumped to the condenser spray system from a remote tank and flows by gravity from the condenser back to the tank. At shutdown, all exposed water drains into the tank, located in a heated space, where it is safe from freezing. The amount of water needed to successfully operate the system depends on condenser size and volume of water contained in the piping system to and from the condenser. Select a tank large enough to contain those combined volumes, plus a level sufficient to maintain a flooded suction on the pump. Control makeup water according to the level where the tank stabilizes during operation.

System Cleanliness

The Cube Evaporative Condenser can be a very effective air washer. Atmospheric dust and particulates able to pass through the relatively small louver or screen openings will enter the recirculating water system. Increased concentrations can intensify systems maintenance by clogging screens and strainers—and smaller particulates can coat system heat transfer surfaces. In areas of low flow velocity, such as the collection basin, sedimentary deposits can provide a breeding ground for bacteria. In areas prone to dust and particulates, consider installing some means for keeping the collection basin clean. Typical devices include basin sweeper piping in conjunction with side stream filters and a variety of filtration media.

Blowdown

Blowdown or bleed-off is the continuous removal of a small portion of the water from the open recirculating system. Blowdown is used to prevent the dissolved solids from concentrating to the point where they will form scale. The amount of blowdown required depends on the heat load and the composition of the makeup water. The Cube Condenser is equipped with a blowdown line with metering valve connected directly to the overflow. Specific blowdown adjustment instructions and additional blowdown information can be found in the applicable *Cube Condenser User Manual*.

Water Treatment

To control the buildup of dissolved solids resulting from water evaporation, as well as airborne impurities and biological contaminants including Legionella, an effective, consistent water treatment program is required. Simple blowdown may be adequate to control corrosion and scale, but biological contamination can only be controlled with biocides. An acceptable water treatment program must be compatible with the variety of materials incorporated in the condenser. Ideally the pH of the recirculating water should fall between 6.5 and 9.0. Batch feeding of the chemicals directly into the condenser is not recommended since localized damage is possible. Specific startup instructions and additional water quality recommendations can be found in the *Cube Condenser User Manual* which accompanies the condenser and also is available from your sales representative.

Air Circulation

Considering the air path entering and exiting the condenser is critical to ensure the condenser operates as designed. Obstructions near the air inlet(s) and discharge should be located a sufficient distance away so as not to impede airflow. If the condenser is to be located in an enclosure or near tall barriers, the air discharge should be positioned at an elevation higher than the top of the barriers to discourage recirculation of the hot discharge air. The condenser must be located at such distance and direction to avoid the possibility of contaminated discharge air being drawn into building fresh air intake ducts.

Piping

Always follow accepted engineering practices during design and installation of condenser piping. All piping must be supported independent of the condenser—no loads are to be supported by the condenser coil connections or condenser structure. Precautions must be taken to protect the condenser from excess heat generated during welding.

Furnish and install an induced draft, counterflow, evaporative condenser with a condensing capacity of _____ MBH heat rejection while operating with _____ refrigerant at _____°F condensing temperature and _____°F entering wet-bulb temperature.

Unit shall consist of _____ cell(s), as shown on plans. The limiting overall dimensions of the condenser shall be _____ft wide, _____ft long, and _____ft high. Total operating power of all fans shall not exceed _____ hp, consisting of _____@ _____ hp motor(s). Tower shall be similar and equal in all aspects to Cube DTC Evaporative Condenser Model _____.

Collection Basin and Casing: The collection basin and casing shall be heavy-gauge G-235 galvanized steel. To reduce potential for leaks, bolts shall be used in all submerged areas; self-tapping screws are not permitted. A factory-installed, float operated, mechanical make-up valve shall be included. An overflow and drain connection shall be provided in each cell. The basin floor shall slope towards the drain to allow complete flushing of debris. The collection basin shall be tested for leaks at the factory.

Fan Motor: Fan motor(s) shall be NEMA Premium Efficiency, TEFC, 1.15 service factor, variable torque, inverter ready and insulated for cooling tower duty, with each motor serving a single fan drive assembly. Motors shall be name plated for 3 phase, 60 Hz, _____ volt operation.

Fan: Fan(s) shall be propeller-type, incorporating aluminum alloy blades attached to galvanized hubs with U-bolts. Blades shall be individually adjustable. Fan(s) shall be driven through a right angle, industrial duty, oil lubricated, geared speed reducer that requires no oil changes for the first five (5) years of operation. All gearbox bearings shall be rated at an L_{10A} service life of 100,000 hours or greater and the gear sets shall have AGMA Quality Class of 9 or greater. The top of the fan cylinder shall be equipped with a conical, non-sagging, removable fan guard, fabricated of welded 5/16" and 7 gauge rods, and hot dip galvanized after fabrication.

Pump: Recirculation pump(s) shall be centrifugal with mechanical seal, mounted to the collection basin in conjunction with a suction assembly, and close-coupled with a _____hp TEFC pump motor name plated for 3 phase, 60 Hz, _____volt operation. Recirculation piping shall be schedule 40 PVC. A blowdown line with metering valve shall be connected directly to the evaporative condenser overflow.

Heat Transfer Coil: Condenser coil(s) shall be constructed of continuous serpentine circuits assembled into fully welded headers and hot dip galvanized after fabrication. Each coil shall be tested at 375 psig air pressure under water. Coil tubes shall be sloped for free drainage of fluid.

Water Distribution: A pressurized spray system shall distribute water evenly over the coil surface with large-orifice, clog resistant spray nozzles that are threaded for easy removal. The distribution header shall be self-draining, with removable corrosion resistant PVC branch arms.

Drift Eliminators: Drift eliminators shall be 17 mil thick PVC with a minimum of three changes in air direction, and shall limit drift losses to 0.001% or less of the design recirculating water flow rate. Eliminators shall be easily removable for inspection.

Louvers: Air inlet louvers shall be a minimum of 5" air travel, triple pass PVC to limit water splash-out and prevent direct sunlight from entering the collection basin. For ease of service and long life, PVC louvers shall be enclosed in a removable frame that attaches to the air inlet without tools. Louvers with less than three changes in air direction are unacceptable.

Cube evaporative condenser

ENGINEERING DATA AND SPECIFICATIONS

SGS REFRIGERATION, INC.

827 W. PROGRESS DRIVE
DIXON, IL 61021 USA
815 284 2700 | sales@sgsrefrigeration.com
sgsrefrigeration.com

CUBE-DTC-TS-16 | ISSUED 03/2016

COPYRIGHT © 2016 SGS Refrigeration, Inc.

In the interest of technological progress, all products are subject to design and/or material change without notice.

Marley is a registered trademark of SPX Corporation

