

# CF Series centrifugal cooler

INSTALLATION - OPERATION - MAINTENANCE

E207093R1 ISSUED 02/2020

READ AND UNDERSTAND THIS MANUAL PRIOR TO OPERATING OR SERVICING THIS PRODUCT.

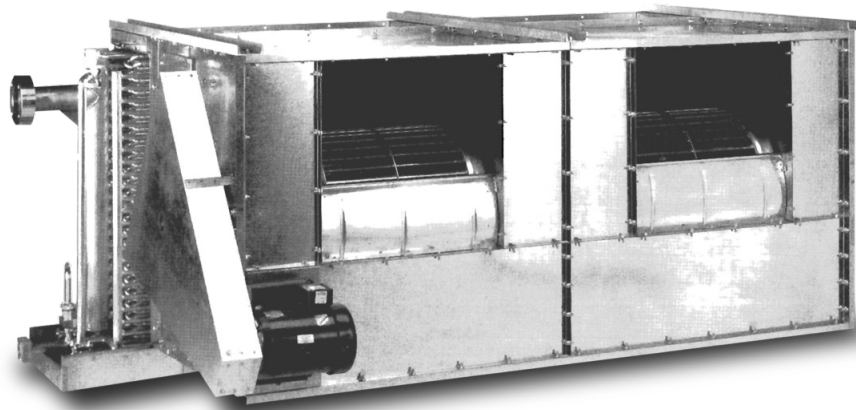

---

# contents

1	Receipt of Equipment .....	3
1.1	Inspection .....	3
1.2	Loss of Gas Holding Charge .....	3
2	Assembly of Components .....	3
2.1	Shipped Loose Parts .....	3
2.2	Motor .....	3
2.3	Belt Attachment .....	3
2.4	Belt Tensioning .....	3
2.5	Belt Guard .....	4
2.6	Bearing Grease .....	4
2.7	Water Defrost Splash Guard .....	4
2.8	Air Filters .....	4
2.9	Air Directional Louvers .....	4
3	Rigging Instructions .....	4
4	Unit Location and Mounting .....	4
4.1	Unit Location .....	4
4.2	Mounting .....	4
5	Refrigerant Warning .....	5
6	Piping Installation .....	5
6.1	Drain Line .....	5
6.2	Refrigeration Piping .....	6
6.3	Hot Gas Interpiping .....	6
6.4	Refrigerant Distributor Nozzle .....	6
6.5	Expansion Valve (optional item) .....	6
6.6	Evacuation and Leak Test .....	7
6.7	DXA and Suction Accumulators .....	7
7	Electrical .....	7
7.1	Field Wiring .....	7
7.2	Electrical Data .....	7
7.3	Suggested No Defrost Requirement Sequence of Operation .....	12
7.4	Suggested Air Defrost Sequence of Operation .....	12
7.5	Suggested Electric Defrost Sequence of Operation .....	12
7.6	Suggested Hot Gas Defrost Sequence of Operation .....	13
7.7	Suggested Water Defrost Sequence of Operation .....	13
8	Operation .....	14
8.1	Pre-Startup .....	14
8.2	Operation Checkout .....	14
9	Maintenance .....	15
9.1	Drain Pan .....	15
9.2	Coil and Cabinet .....	15
9.3	Bearings .....	15
9.4	Motor.....	15
9.5	Belt Drive .....	15
9.6	Electric Defrost Heaters .....	15
9.7	Fan Shaft .....	15
9.8	Air Filters .....	16
10	Replacement Parts List .....	16

# receiving and installation

## 1 RECEIPT OF EQUIPMENT

### 1.1 INSPECTION

All equipment should be carefully checked for damage or shortages as soon as it is received. Each shipment should be carefully checked against the bill of lading. If any damage or shortage is evident, a notation must be made on the delivery receipt before it is signed and a claim should then be filed against the freight carrier. Inspection and claims are the responsibility of the recipient.

A large multi-belt sheave should be mounted to the end of the fan shaft. Rotate fan shaft by hand to be sure the fan shaft has not bent during shipment, and that the fans do not strike the housing.

### 1.2 LOSS OF GAS HOLDING CHARGE

Every CF Series II unit is leak tested, evacuated to remove moisture and then shipped with a gas holding charge. Absence of this charge may indicate a leak has developed in transit. The system should not be charged with refrigerant until it is verified that there is no leak, or the source of the leak is located. If the unit contains aluminum tubes or flanged refrigerant connections, the unit is leak tested and evacuated but a gas holding charge is not provided.

## 2 ASSEMBLY OF COMPONENTS

### 2.1 SHIPPED LOOSE PARTS

Motor (with sheave attached), bolts, nuts and washers (on small units the motor may be factory mounted)

Drive belts (strapped to fan sheave)

Belt guard, bolts and washers (bolts and washers are located in their final assembly holes on fan cabinet)

Water defrost splash guards (may be factory mounted)

Air filters (optional item supplied by others)

Optional air directional louvers with required assembly bolts, nuts and washers

### 2.2 MOTOR

If the motor is factory mounted, make sure the fan shaft contains a factory mounted sheave. If the motor is shipped loose, mount the motor onto the adjustable motor mount that is already on the fan cabinet using the provided bolts, nuts, and washers. After attachment to the unit the motor shaft should be facing away from the fan cabinet.

**IMPORTANT:** Make sure the motor and fan sheaves are aligned and parallel with each other (belt manufacturer recommends alignment within 0.5°). Using a long straight edge, lay the straight edge against the faces of the sheaves. If each sheave contacts the straight edge in two places the sheaves are lined up. See Figure 1.

**WARNING:** Make sure the unit is electrically grounded. Newer drain piping and electrical conduit may not be metal, or attached to a support that is grounded.

### 2.3 BELT ATTACHMENT

The motor mount adjusting screw needs to be fully CLOSED. Wrap one belt around the outer most groove on the fan sheave then wrap the belt around the outer most groove of the motor sheave. Belts should never be forced over sheaves. Typically a CF Series II unit uses sheaves with two or more grooves, requiring that the belt be moved to the inner most groove. Move the belt on the motor sheave over one groove, then move the belt on the fan sheave over one groove. Repeat moving the belt in a similar manner until the first belt is in the inner most groove of both sheaves. Repeat the belt attachment procedure for each belt until every sheave groove contains a belt.

### 2.4 BELT TENSIONING

Turn the motor mount adjusting screw(s) so that the motor tilts away from the fan shaft, tightening the belts. The amount of belt "free play" should be the distance between the sheave centers divided by 64, when the motor mount is properly adjusted.

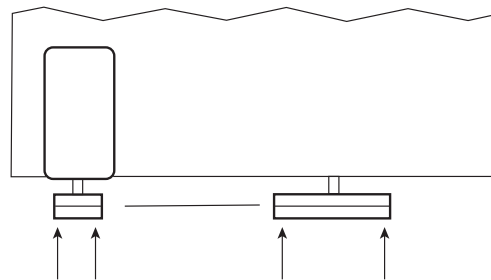

Sheaves have 4 points aligned and parallel

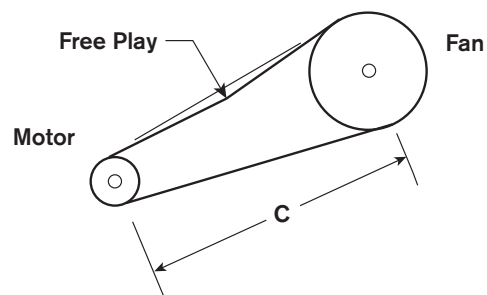

FIGURE 1 Sheave alignment and free play

---

# receiving and installation

## 2.5 BELT GUARD

The belt guard attachment bolts have been shipped “in place” on the fan cabinet sheetmetal. Remove the bolts and washers before positioning the belt guard. Align the hole in one of the belt guard mounting brackets with the pre-installed nut in the fan cabinet sheetmetal. Partially screw in the bolt and washers to use as a pivot, then align the other brackets to rest of the nuts and screw in the rest of the bolts and washers. Tighten bolts snugly.

## 2.6 BEARING GREASE

The fan shaft bearings are greased at the factory before shipment.

## 2.7 WATER DEFROST SPLASH GUARD

If the water defrost splash guard is shipped loose, align the holes in the guard to the holes on the bottom horizontal support angle on the air inlet side of the evaporator. Use the bolts and nuts provided with the splash guard to hold it in place.

## 2.8 AIR FILTERS

The unit drawing supplied with the unit shows the air filter orientation within the filter section. Install the filters from one side by opening the access door and sliding the correct height filter onto each of the tracks. Insert the next filter onto the track, pushing the first filter further into the unit. Continue adding filters until the first filter contacts the opposite closed access door. Repeat for each track. To replace the filter set open both access doors and slide the new filters onto each of the tracks, pushing the old filters out of the unit at the opposite end.

## 2.9 AIR DIRECTIONAL LOUVERS

The CF Series unit may have optional Air Directional Louvers supplied. The louvers for each fan outlet are assembled, but shipped loose from the unit. The installer should attach the louver assembly so that the louver direction matches the unit drawing. Bolts, nuts, and washers are supplied with the assembly.

## 3 RIGGING

A CF Series II unit tends to be a long and heavy object, with about 2/3 of the weight contained in the coil element at the rear of the unit. Jobsite requirements will affect the method of raising the unit in place. Carefully consider the support that is required to lift and move the unit. Under no circumstances should the shipping skid be used for lifting the unit. To ensure that the unit is not bowed or damaged when being lifted into place from above, all leg or hanger points should be used. If the unit is being lifted into place from underneath, a level support directly under all of the shipping legs is required to adequately steady the unit as it is lifted to the hanger rods.

## 4 UNIT LOCATION AND MOUNTING

### 4.1 UNIT LOCATION

Unit must be located to provide good air circulation to all areas. If an air distribution duct is not to be attached to the fan outlet(s), the unit should be positioned to blow the air away from walls and directed down an aisle, over product, or into product as the room design is specified. For best performance it is desirable to arrange the air discharge toward the door of the room to minimize the entrance of warm moist air when the door is open. Light fixtures, shelving, ceiling structures, and product boxes must be located so that they do not block the air intake or air discharge from the unit.

**IMPORTANT**—The coil face must be located away from a wall a minimum distance equal to the height of the coil to assure unrestricted air intake.

On all CF Series II units space should be provided for the possible future replacement of the fan shaft(s), or the electric defrost heaters if heaters have been furnished. Space equal to the overall length of the shaft(s) plus twelve inches on either side of the unit is recommended. The electric defrost heater Table 7 shows recommended access dimensions to remove the heater rods.

### 4.2 MOUNTING

The CF Series II units should be suspended with 3/4" diameter threaded STEEL hanger rods (1/2" for the 1F and 2F models). Do not use nylon threaded rods. Rods should have double nuts on the top and bottom. Adequate support must be provided to hold the weight of the unit. Refer to the unit drawing supplied with the unit or the CF Series II catalog for the approximate unit weight and hanger locations. All hanger holes should be used to support the unit. Do not temporarily support a unit using less than all hanger or shipping leg holes. The shipping support legs can be removed after the unit is mounted. If the CF Series II unit is floor or platform mounted, anchor the unit through the holes in the pads at the bottom of each support leg. See unit drawing for hole locations. If the refrigeration system is direct expansion, see sections 6.5 and 6.6.

The unit must be level in all directions to insure proper drainage of the condensate drain pan. Suspended units must have sufficient clearance above for cleaning the top of the unit and repairing the Water Defrost assemblies, if provided.

# installation

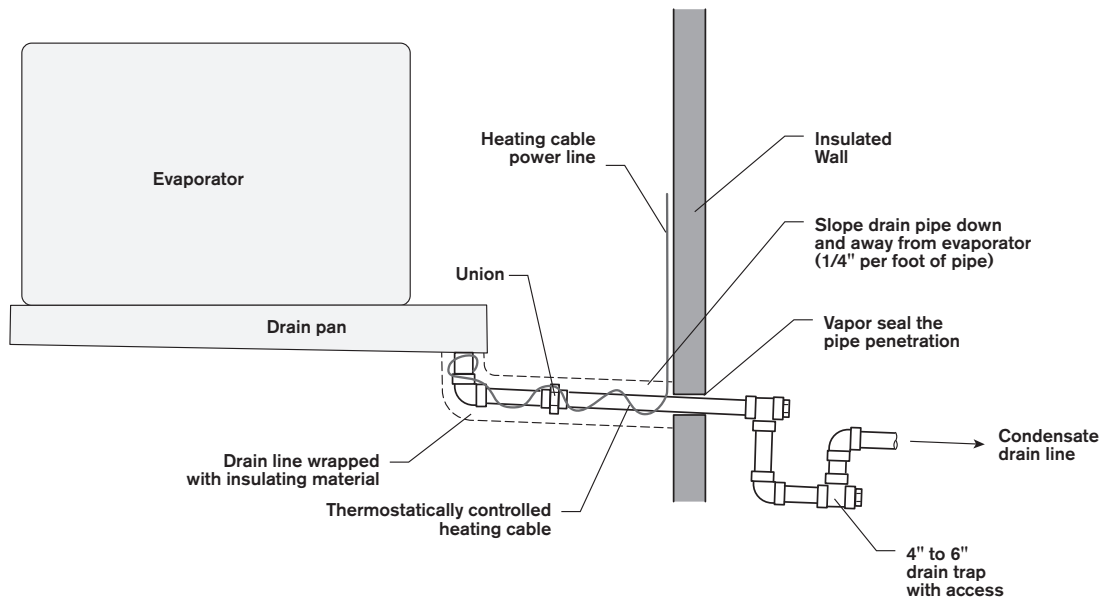

FIGURE 2 Drain Line

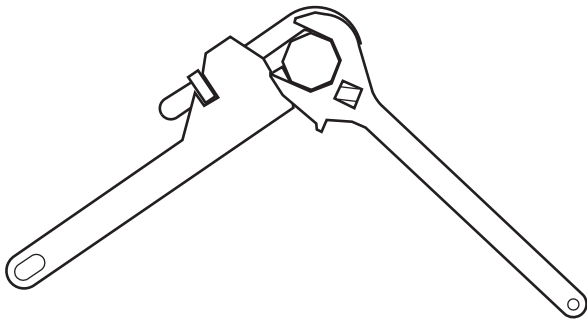

FIGURE 3 Pipe Joining

## 5 REFRIGERANT WARNING

The use of any refrigerant can be dangerous under certain conditions. Where people or product can be exposed to hazardous conditions, daily inspections should be made for the detection of any defect or malfunction that could cause the escape of the refrigerant and cause harm. In the case of halocarbon refrigerants, electronic detection devices are available for sensing the presence of such refrigerants in the atmosphere.

**Ammonia** is a “self-alarming” gas with its strong odor but detection devices are strongly recommended. People and product are a concern based on the concentration levels (ppm) of ammonia

along with OSHA and EPA regulations. An ammonia gas detection device connected to an external alarm system to warn that a leak is occurring is recommended. Refer to local codes and Fire Department for additional local regulations.

Only experienced, qualified personnel should install, operate, and maintain detection and alarm equipment.

## 6 PIPING INSTALLATION

### 6.1 DRAIN LINE

The drain line should be as short and as steeply pitched as possible with a minimum of 1/4” drop per running foot. The drain line should be of the same, or larger, pipe size as the drain connection. A drain line trap should be installed to prevent warm moist air from migrating through the drain line. If the temperature surrounding the drain line is below freezing (32°F) it must be wrapped with a drain line heater and insulation. Be sure to also wrap the drain pan coupling. The drain line heater must be energized continuously. Be sure to follow the manufacturer’s recommendation when installing the drain line heat tape. The drain line trap should be outside of the freezing space. See Figure 2.

A union at the drain connection in the drain pan is recommended for ease of installation and future servicing. The union should be located just outside the edge of the drain pan so that when the pan is lowered for cleaning or repair the drain line run is not in the way. Use two wrenches when tightening to prevent the drain fitting from twisting and damaging the drain pan. See Figure 3.

Long runs of drain line, i.e. more than a few feet, should be supported by hangers to avoid damage to the drain pan.

---

# installation

## 6.2 REFRIGERATION PIPING

Installation design must conform to all local and national codes, laws and regulations applying to the site of installation. In addition the safety code for mechanical refrigeration, ASME B31.5, should be followed as a guide to safe installation and operation practice.

Refrigerant line sizes, piping support, and piping techniques should be obtained from published recognized refrigeration standards. Under no circumstances should the refrigerant connection size of the unit be used as the basis for sizing the lines.

For aluminum flange union connections see Figure 3 for final assembly drawing.

**IMPORTANT**—The CF Series II units have not been designed to carry the weight of any external piping or valves. Improper support of external piping and valves may result in unit breakage and refrigerant spillage.

The horizontal suction line should slope away from the unit. Vertical suction risers on halocarbon systems require a properly sized “P” trap at the foot of the riser for proper oil return.

## 6.3 HOT GAS INTERPIPING

If the unit was ordered with hot gas defrost the drawing shipped with the unit will contain the piping connection locations for the hot gas inlet and the condensate relief.

## 6.4 REFRIGERANT DISTRIBUTOR NOZZLE

For a direct expansion system, the CF Series II units already have the distributor nozzle installed. As a check, see that the nozzle is in the distributor, or the auxiliary hot gas tee for direct expansion halocarbon with hot gas defrost, before installing the thermal expansion valve to the distributor or auxiliary hot gas tee.

## 6.5 EXPANSION VALVE (optional item)

Before mounting a direct expansion system unit, install the expansion valve and connect the equalizer tube. The expansion valve should be installed directly to the distributor body or as close as possible with no elbows or bends. Steel expansion valves for direct expansion ammonia requires the removal of the discharge tube. Locate the expansion valve bulb on a horizontal length of suction line as close to the suction header as possible. Position the bulb in a 3, 4, 8, or 9 o'clock position. Do not position the bulb on the top or the bottom of the pipe. Clamp the bulb down flush and tightly against the pipe and insulate. Never locate the bulb on a trap or downstream from a trap.

Expansion valves are NOT adjusted at the factory prior to shipment. It is important that the operation of the expansion valve be checked after the system has balanced out at the desired room temperature. If the coil is being starved it is necessary to reduce the superheat setting of the valve by turning the adjusting stem counter-clockwise. If the superheat is too low it is necessary to increase the superheat setting of the valve by turning the adjusting stem clockwise. It is recommended that for a 10°F to 12°F T.D. system, the valve be adjusted to maintain 5°F to 6°F of superheat.

# installation

## 6.6 EVACUATION AND LEAK TEST

When all refrigeration connections have been completed, the entire system must be tested for leaks and then evacuated.

## 6.7 DXA AND SUCTION ACCUMULATORS

Do not use units with Direct Expansion Ammonia (DXA) feed below 0°F evaporating temperatures unless the compressor system is designed and protected to handle the overfed liquid by use of a suction accumulator.

## 7 ELECTRICAL

If the CF Series II unit is equipped with an electrical power disconnect switch make sure the switch is in the “OFF” position, preferably locked in this position.

### 7.1 FIELD WIRING

Field wiring should comply with NEC and local codes. The power supply voltage, phase and frequency must match what is shown on the unit data plate. Wire motor so that the exposed part of the fan wheel(s) turns toward the air discharge opening of the unit.

Wiring for a unit with Air, Hot Gas, or Water Defrost, without a SGS mounted electrical panel, requires power to the fan motor only. If the unit is supplied with Electric Defrost, but no control panel, wiring will be required to the mounted terminal blocks for the defrost heaters and also directly to the motor. See Figure 4 for typical unit wiring with 230/3/60 power or Figure 5 for 460/3/60 power. If a SGS mounted control panel is provided, wiring to only one set of terminal blocks is required. See wiring diagram supplied with unit.

A motor in a cold room may draw greater than nameplate amperage due to denser, colder air flowing through the unit. For a motor requiring external overload protection, measure motor amps after pulldown and select correct motor overloads for the measured amperage. Also compensate for the variance in ambients between motor and overload locations. Motor overload protection is recommended for all phase legs. All wiring must be in accordance with the governing electrical code.

### 7.2 ELECTRICAL DATA

Table 1 – Motor Amps (approximate)

Motor hp	208/3/60	230/3/60	460/3/60	575/3/60
1	3.1	3.0	1.5	1.2
1.5	4.5	4.4	2.2	1.8
2	6.6	5.8	2.9	2.3
3	9.0	8.4	4.2	3.3
5	13.9	13.4	6.7	5.3
7	20.0	19.0	9.5	7.6
10	26.5	24.4	12.2	9.6
15	38.0	36.2	18.1	14.6
20	52.0	48.0	24.0	19.2
25	64.0	62.0	31.0	24.0

# installation

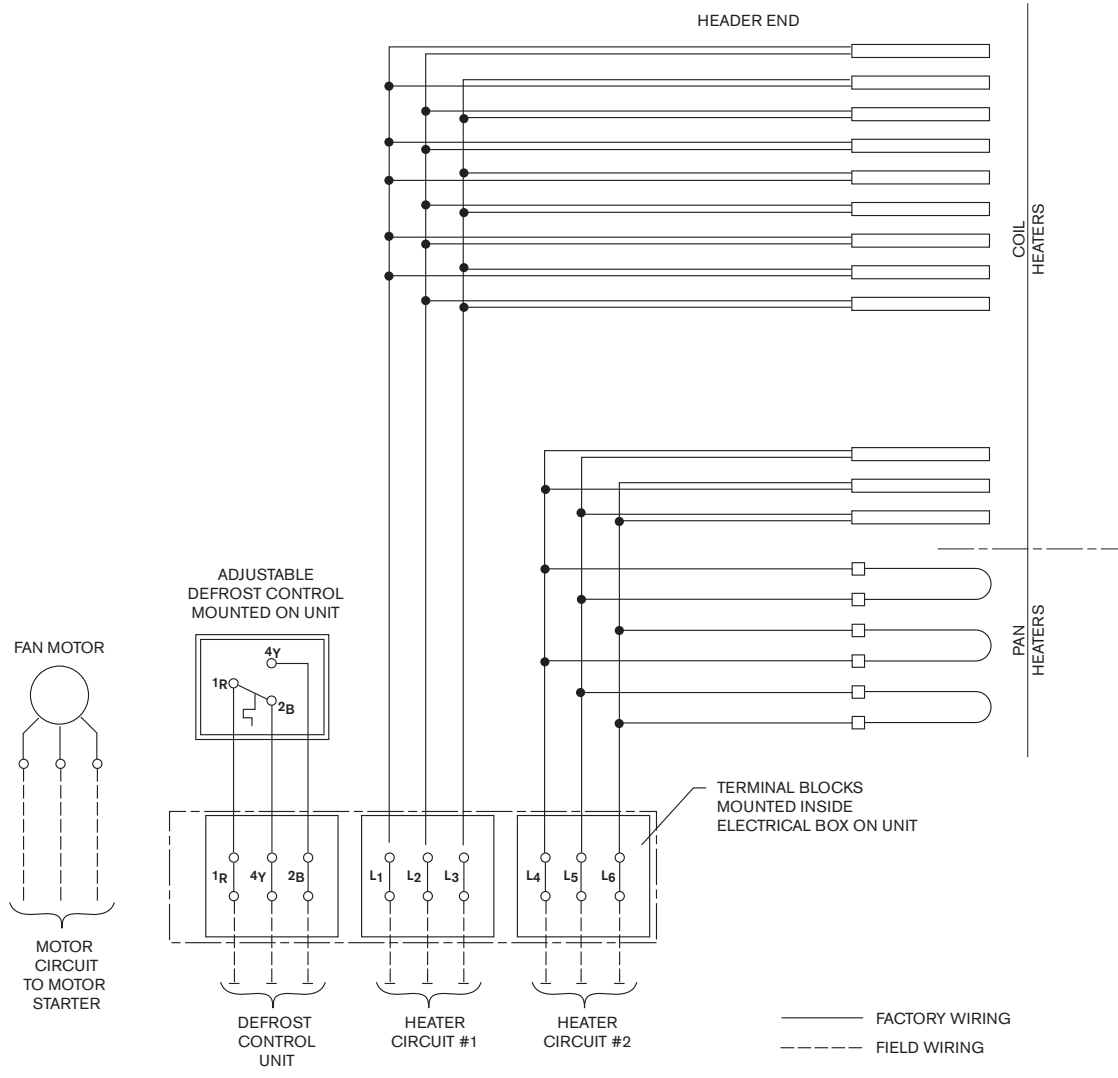

**FIGURE 4** Electric Defrost Wiring 208/3/60 – 230/3/60



# installation

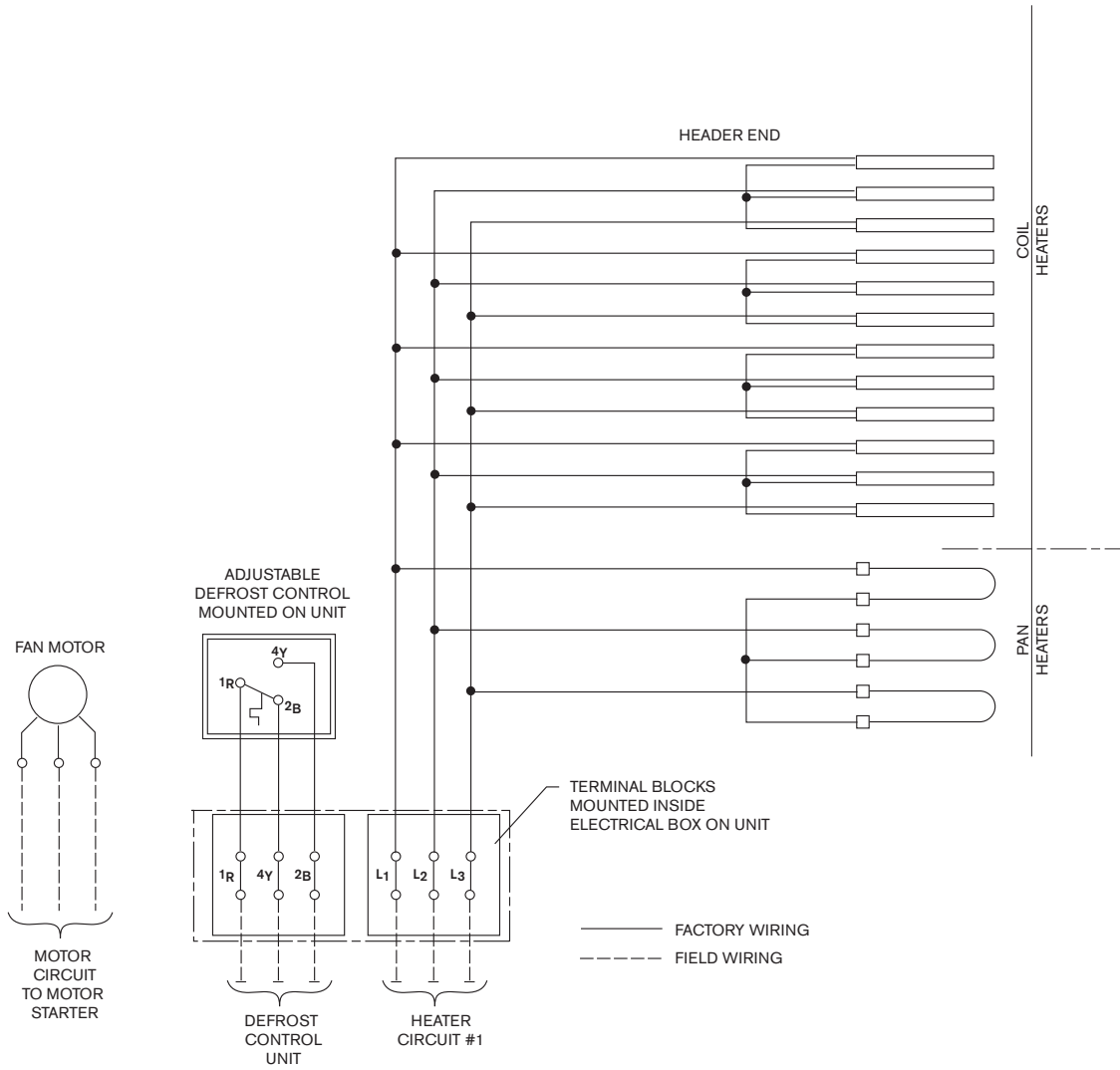

**FIGURE 5** Electric Defrost Wiring 460/3/60 – 575/3/60 – 380/3/50

# installation

Unit Model	208/3/60	230/3/60	460/3/60	575/3/60	380/3/50	Heater Access in
1F-096	10.9	12.0	6.0	4.8	6.6	41*
1F-098	16.3	18.1	9.0	7.2	10.0	
2F-186	21.8	24.1	12.0	9.6	13.3	41**
2F-188	32.7	36.1	18.1	14.5	19.9	
1G-206	24.5	27.1	13.6	10.8	14.9	64*
1G-208	32.7	36.1	18.1	14.5	19.9	
1C-246	32.7	36.1	18.1	14.5	19.9	64*
1C-248	40.9	45.2	22.6	18.1	24.9	
1D-286	40.9	45.2	22.6	18.1	24.9	64*
1D-288	49.0	54.2	27.1	21.7	29.9	
1A-326	57.2	63.3	31.6	25.3	34.8	64*
1A-328	65.4	72.3	36.1	28.9	39.8	
2G-336	40.9	45.2	22.6	18.1	24.9	52**
2G-338	54.5	60.2	30.1	24.1	33.2	
2C-396	54.5	60.2	30.1	24.1	33.2	52**
2C-398	68.1	75.3	37.7	30.1	41.5	
2G-406	49.0	54.2	27.1	21.7	29.9	64**
2G-408	65.4	72.3	36.1	28.9	39.8	
2H-466	68.1	75.3	37.7	30.1	41.5	52**
2H-468	81.7	90.4	45.2	36.1	49.8	
2C-486	65.4	72.3	36.1	28.9	39.8	64**
2C-488	81.7	90.4	45.2	36.1	49.8	
3G-506	61.3	67.8	33.9	27.1	37.3	80**
3G-508	81.7	90.4	45.2	36.1	49.8	
2H-546	95.3	105.4	52.7	42.2	58.1	52**
2H-548	109.0	120.5	60.2	48.2	66.4	
2D-566	81.7	90.4	45.2	36.1	49.8	64**
2D-568	98.1	108.4	54.2	43.4	59.7	
3C-596	81.7	90.4	45.2	36.1	49.8	80**
3C-598	102.2	113.0	56.5	45.2	62.2	
2A-646	114.4	126.5	63.3	50.6	69.7	64**
2A-648	130.8	144.6	72.3	57.8	79.6	
3H-696	102.2	113.0	56.5	45.2	62.2	80**
3H-698	122.6	135.6	67.8	54.2	74.7	

\*Heater removal is required at the refrigerant connection end of the unit

\*\*Heater removal is required at both ends of the unit

# installation

Unit Model	208/3/60	230/3/60	460/3/60	575/3/60	380/3/50	Heater Access in
1F-096	18.4	20.3	10.2	8.1	11.2	41*
1F-098	23.8	26.4	13.2	10.5	14.5	
2F-186	36.8	40.7	20.3	16.3	22.4	41**
2F-188	47.7	52.7	26.4	21.1	29.0	
1G-206	36.6	40.5	20.2	16.2	22.3	64*
1G-208	44.8	49.5	24.8	19.8	27.3	
1C-246	44.8	49.5	24.8	19.8	27.3	64*
1C-248	61.1	67.6	33.8	27.0	37.2	
1D-286	53.0	58.6	29.3	23.4	32.2	64*
1D-288	69.3	76.6	38.3	30.6	42.2	
1A-326	69.3	76.6	38.3	30.6	42.2	64*
1A-328	85.6	94.7	47.3	37.9	52.2	
2G-336	60.1	66.4	33.2	26.6	36.6	52**
2G-338	73.7	81.5	40.7	32.6	44.9	
2C-396	73.7	81.5	40.7	32.6	44.9	52**
2C-398	100.9	111.6	55.8	44.6	61.5	
2G-406	72.2	79.8	39.9	31.9	43.9	64**
2G-408	88.5	97.9	48.9	39.1	53.9	
2H-466	87.3	96.6	48.3	38.6	53.2	52**
2H-468	114.6	126.7	63.3	50.7	69.8	
2C-486	88.5	97.9	48.9	39.1	53.9	64**
2C-488	121.2	134.0	67.0	53.6	73.8	
3G-506	89.7	99.2	49.6	39.7	54.6	80**
3G-508	110.1	121.8	60.9	48.7	67.1	
2H-546	114.6	126.7	63.3	50.7	69.8	52**
2H-548	141.8	156.8	78.4	62.7	86.4	
2D-566	104.9	115.9	58.0	46.4	63.9	64**
2D-568	137.5	152.1	76.0	60.8	83.8	
3C-596	110.1	121.8	60.9	48.7	67.1	80**
3C-598	151.0	167.0	83.5	66.8	92.0	
2A-646	137.5	152.1	76.0	60.8	83.8	64**
2A-648	170.2	188.2	94.1	75.3	103.7	
3H-696	130.6	144.4	72.2	57.7	79.5	80**
3H-698	171.4	189.5	94.8	75.8	104.4	

\*Heater removal is required at the refrigerant connection end of the unit

\*\*Heater removal is required at both ends of the unit

---

# installation

## **7.3 SUGGESTED NO DEFROST REQUIREMENT SEQUENCE OF OPERATION**

Used for units with a suction temperature above freezing.

- A. When the room thermostat calls for cooling, refrigerant begins flowing to the unit.
- B. The fan motor is energized.
- C. When the thermostat is satisfied, refrigerant stops flowing to the unit.
- D. The fan motor continues to run until the refrigerant is completely boiled out of the tubes, then the fan motor is de-energized.

## **7.4 SUGGESTED AIR DEFROST SEQUENCE OF OPERATION**

Used for units with a suction temperature below freezing, but a room temperature above 36°F.

- A. A defrost timer is wired into the fan motor controls.
- B. The timer turns off the liquid line solenoid valve at a predetermined time.
- C. The refrigerant in the unit boils off, continuing the cooling cycle.
- D. When the refrigerant is completely boiled out of the unit, the fan motor continues to operate so that the room air temperature melts the coil frost.
- E. At a second predetermined time the timer energizes the liquid line solenoid valve.

The timer settings are to be programmed per the need of the job site.

## **7.5 SUGGESTED ELECTRIC DEFROST SEQUENCE OF OPERATION**

Used for units with a suction temperature below freezing. The Electric Defrost cycle is time clock initiated and temperature terminated. Two to three defrost cycles per 24 hour period are typical. The following sequence is based on the Paragon 8145 or equal time clock.

- A. Power is supplied to the defrost timer.
- B. The defrost termination thermostat is off and the defrost heaters are off.
- C. The unit operates in cooling mode.
- D. Upon initiation of the defrost cycle the time clock turns off the liquid line solenoid valve.
- E. After a site determined time period the timer de-energizes the fan motor and energizes the defrost heaters.
- F. The heaters, positioned within the coil turbo spacers in the fin pack, heat up the fins directly to melt the accumulated frost.
- G. When the coil reaches the temperature setting of the defrost termination thermostat the thermostat closes, telling the defrost timer to cut off power to the heaters.
- H. The defrost timer energizes the liquid line solenoid valve, allowing refrigerant to flow into the unit, cooling the coil and refreezing any remaining condensate drops that are still present.
- I. The fan motor is started through the fan delay thermostat temperature setting, putting the unit in the cooling cycle.

The timer settings and the adjustable defrost termination fan delay thermostat settings are to be programmed per the need of the job site.

---

# installation

## 7.6 SUGGESTED HOT GAS DEFROST SEQUENCE OF OPERATION

Used for units with a suction temperature below freezing. The Hot Gas Defrost cycle is time clock initiated and terminated. The following sequence is based on the Hansen Frost Master or equal time clock.

- A. Power is supplied to the defrost timer.
- B. The unit operates in the cooling cycle.
- C. Upon initiation of the defrost cycle, the defrost time clock turns off the liquid line solenoid valve. The fan motor continues to operate to boil off the remaining refrigerant in the coil tubes.
- D. After a predetermined time period the defrost timer de-energizes the fan motor and energizes the hot gas supply solenoid valve.
- E. Hot gas flows into the unit and warms up the tubes and fins (and drain pan if an HGU unit), melting the accumulated frost.
- F. Approximately ten minutes after starting the hot gas defrost cycle the defrost time clock should de-energize the hot gas supply solenoid valve. If the unit is in defrost for a much longer period of time the condensate on the tubes and fins could "steam" and refreeze on the fan cabinet, fan(s), or shaft causing maintenance problems.
- G. The defrost time clock should allow the coil to vent, allowing any remaining gas to escape the coil.
- H. The defrost timer energizes the liquid line solenoid valve allowing refrigerant to flow into the unit, cooling the coil and refreezing any remaining condensate drops that are still present.
- I. The fan motor is energized after a preset fan delay in the time clock and the unit is in the cooling cycle.

The timer settings are to be programmed per the need of the job site.

## 7.7 SUGGESTED WATER DEFROST SEQUENCE OF OPERATION

Used for units with a suction temperature below freezing. The Water Defrost cycle is time clock initiated and terminated.

- A. Power is supplied to the defrost timer.
- B. The unit operates in the cooling cycle.
- C. Upon initiation of the defrost cycle, the defrost time clock turns off the liquid line solenoid valve. The fan motor continues to operate to boil off the remaining refrigerant in the coil tubes.
- D. After a predetermined time period the defrost timer de-energizes the fan motor and energizes the water supply solenoid valve.
- E. Water flows onto the unit and warms up the tubes, fins, and drain pan, melting the accumulated frost.
- F. Approximately ten minutes after starting the water defrost cycle the defrost time clock should de-energize the water supply solenoid valve.
- G. The defrost time clock should allow the remaining water to drip off of the coil surface.
- H. The defrost timer energizes the liquid line solenoid valve allowing refrigerant to flow into the unit, cooling the coil and refreezing any remaining condensate drops that are still present.
- I. The fan motor is energized after a preset fan delay in the time clock and the unit is in the cooling cycle.

The timer settings are to be programmed per the need of the job site.

---

# operation

## 8.0 OPERATION

### 8.1 PRE-STARTUP

After the installation is completed, a review of the following items should be preformed before the system is placed into operation:

- A. Check electrical connections, sheave bushing set screws, motor mount bolts, belt guard, flange bolts, and all other fasteners for tightness. If required, be sure the thermostatic expansion valve bulb is properly located, strapped, and insulated.
- B. For systems with a defrost time clock check the timer to see that it is set for the correct time of day and the starting pins have been installed (normally two or three sets per day). Defrost should be scheduled when the freezer doors are not likely to be open.
- C. When the unit is first started the room temperature is typically above the opening temperature of the fan delay thermostat, if a fan delay thermostat is provided for Electric Defrost units (see that particular unit electrical diagram). The fans may remain off for a lengthy period of time. To prevent this delay it is permissible to install a temporary jumper wire between terminals that contain the Red and Blue wires from the fan delay thermostat. Once the room temperature is below +25°F the jumper wire should be removed.
- D. Make sure that the grease lines to the bearings are filled with grease. See the Maintenance section for recommended grease types.

### 8.2 OPERATION CHECKOUT

With the system operating, check the supply voltage. The voltage must be within +/- 10% of the voltage marked on the unit nameplate and the phase to phase unbalance should be 2% or less.

Check the room THERMOSTAT setting. Be sure it functions properly.

For RECIRCULATED refrigeration systems the hand expansion valve should be opened slowly until either condensate or frost forms on the return bends from the bottom to the top of the coil.

For FLOODED refrigeration systems check to make sure the float valve is working properly and fills the surge drum to the appropriate level and will allow refrigerant into the drum when the liquid level is sufficiently low.

For DIRECT EXPANSION systems let the system balance out

at the desired room temperature and check the operation of the expansion valve by properly measuring the superheat at the sensing bulb. As much as thirty minutes may be required for the new balance to take place after an adjustment is made.

For BRINE or WATER COOLING systems keep the closest vent open while the fluid fills the coil to allow trapped air to escape. Close the valve once fluid flows out of the valve and check for water hammer in the coil.

With HOT GAS DEFROST systems allow the coil to frost, then manually advance the defrost timer to initiate a defrost cycle. Observe the defrost cycle to see if all controls are functioning properly and that the coil is clear of all frost before the system returns to refrigeration. Adjust the time clock pins if necessary. Reset the defrost timer to the correct time of day. A defrost cycle is only needed with the frost build up is such that it impedes the airflow through the coil. The defrost requirements will vary on each installation and may change depending on the time of the year and other conditions.

With ELECTRIC DEFROST systems allow the coil to frost then manually advance the defrost timer to initiate a defrost. Observe the defrost cycle to see if all controls are functioning properly and that the coil is clear of all frost before the system returns to refrigeration. Adjust the time clock pins if necessary. Reset the defrost timer to the correct time of day. A defrost cycle is only needed with the frost build up is such that it impedes the airflow through the coil. The defrost requirements will vary on each installation and may change depending on the time of the year and other conditions.

With WATER DEFROST systems allow the coil to frost then manually advance the defrost timer to initiate a defrost cycle. Observe the defrost cycle to see if all controls are functioning properly and that the coil is clear of all frost before the system returns to refrigeration. Adjust the time clock pins if necessary. Reset the defrost timer to the correct time of day. A defrost cycle is only needed with the frost build up is such that it impedes the airflow through the coil. The defrost requirements will vary on each installation and may change depending on the time of the year and other conditions.

LISTEN CAREFULLY to the unit to make sure there are no unusual sounds. Sounds such as the belts squealing, the bearings running dry, the fan(s) scraping on the housing, the sheaves scraping against the belt guard, or loose fasteners allowing parts to rattle need to be addressed immediately before continued unit operation.

---

# maintenance

## 9 MAINTENANCE

A preventive maintenance schedule should be set up as soon as the CF Series II unit is installed. The unit should be inspected periodically for proper operation and build up of soil.

**WARNING:** All power must be off before cleaning or maintenance is performed.

### 9.1 DRAIN PAN

Inspect and clean the drain pan to insure free drainage of condensate. The drain pan should be cleaned regularly with warm water and soap.

If the drain pan needs to be removed, support the long dimension of the pan from underneath with a minimum of two 4x4s for one and two fan units or two 6x6s for three and four fan units so the outer sheetmetal skin does not buckle and become damaged. For longer pans more than one lifting device may be needed to keep the pan balanced when lifting. If the drain pan uses hot gas defrost make sure the coil is completely pumped out and isolated with hand valves to prevent refrigerant from escaping to the atmosphere. Remove the hot gas piping or electric wires if the unit has a hot gas or an electric defrost drain pan. Remove the drain line so that it is out of the way of the pan when it is being lowered. Remove the drain pan attachment bolts from the bottom of the evaporator unit and slowly lower the pan from the unit. Assemble pan in reverse order. Replace hot gas interpipng gaskets before tightening flange bolts.

### 9.2 COIL AND CABINET

Clean the coil, fan cabinet, fan(s), and belt guard with warm water and soap.

The evaporator coil should be checked once a month for proper defrosting. Many variables affect coil frosting such as room temperature, type of product being stored or processed, how often new product is brought in, and the length of time the door to the room remains open. Summer conditions of high humidity can cause heavier frost loads and it may be necessary to change the number of defrost cycles seasonally.

### 9.3 BEARINGS

The use of ball bearings to support the fan shaft will require periodic greasing of the bearings. Greasing should take place between 6 to 12 months for normal duty service and 1 to 6 months for severe duty service, according to site conditions. When greasing use Chevron RRM Arctic, Esso Beacon #325 or equivalent grease. Use a low pressure, not high pressure, gun to avoid over lubrication or destruction of the bearing seals.

### 9.4 MOTOR

If it becomes necessary to add lubricant to the factory furnished motor, follow the motor manufacturers lubrication instructions. .

### 9.5 BELT DRIVE

Inspect motor driven belts for normal wear pattern. If necessary adjust the motor mount to provide approximately one inch of belt "free-play". If replacing a belt is necessary, all belts on the same CF Series II unit must be replaced. Remove the belt guard and adjust the motor mount to allow the belt enough "free-play" to be easily removed. Install the new belts as described in section 2.4. Replace the belt guard. After 24 to 48 hours of operation, again check the belt "free-play" and adjust the motor mount as necessary.

### 9.6 ELECTRIC DEFROST HEATERS

Inspect the electric defrost heater ends to determine if they are operating. A heater will be operating properly when the heater is observed to be glowing during the defrost cycle. If a heater rod is cold during the defrost cycle it will need to be replaced.

Coil heaters require horizontal removal from one end of the unit. On two or three fan units heater rods are on both ends of the unit. Remove heater wire from terminal block and note where original wires were located. Rotate the heater rod so that the heater and retainer clip can be slid through the coil endplate slot. Remove clip from the old heater rod and install on the new heater rod in approximately the same location as the original heater. Install new heater rod in the coil original coil slot, rotate the rod 90°, and replace the wires in the positions of the original wires in the terminal block.

Drain pan heaters require the drain pan to be removed. Support the long dimension of the pan from underneath with a minimum of two 4x4s for one and two fan units or two 6x6s for three and four fan units so the outer sheetmetal skin does not buckle and become damaged. For longer pans more than one lifting device may be needed to keep the pan balanced when lifting. Remove the heater wires from the terminal block(s). Remove the drain line so that it is out of the way of the pan when it is being lowered. Remove the drain pan attachment bolts from the bottom of the evaporator unit and slowly lower the pan from the unit. Remove the nuts from the heater hold down brackets and remove the brackets. Replace the heater. Replace the hold down brackets and assemble the pan in reverse order. Rewire the heaters in the original terminal block(s).

### 9.7 FAN SHAFT

The fan shaft usually does not require any maintenance. If a shaft is determined to be damaged and needs to be replaced, remove the belt guard, belts, and sheave. After any safety collar, bushing, or setscrew is loosened from the shaft removal process file any metal burr that may be present on the shaft. Burr removal prevents damage to the bearing bore surface as the shaft is removed from the bearing. Remove the small curved deflector plate from in front of the blower wheel and place a block under the blower wheel



# maintenance

so the blower housing will support the wheel when the shaft is removed. Remove bearings and bearing support plates. Remove shaft horizontally from unit. Install new shaft in the reverse order.

## 9.8 AIR FILTERS

See Section 2.7 for air filter replacement procedure.

## 10 REPLACEMENT PARTS LIST

Listed below are the major replacement parts of the standard CF Series II units. The sheaves, bushings, and belts are sized per project, requiring the specific unit model number and serial number for proper replacement part selection. Call sales representative or factory to identify replacement parts.

Motor hp	Part Number		
	230/460V	575V	380V
1	E314167	call	call
1.5	E311896	call	call
2	11517	call	E315714
3	11519	E315514	E314373
5	11520	E311765	E313616
7.5	11092T	E311388	E313212
10	E311619	E313891	E312978
15	E312051	E312564	E313211
20	E312696	call	call
25	E312664	call	E313653

Fan Number	Part Number	
	Wheel	Housing
A	E312163	E312164
B	E312370	E312371
C	E311189	E311188
D	E311964	E311963
E	E312368	E312369
F	11286	11287
G	E312288	E312289
H	E312372	E312373

Unit Size	Part Number			
	Shaft	Motor End Bearing	Opposite End Bearing	Internal Bearing
1 Fan ( 09 )	E315682	10509	10509	
1 Fan ( 20, 24, 28, 32 )	E312304	10510	10177	
2 Fan ( 18 )	E315683	10509	10509	
2 Fan ( 31, 33, 39, 46, 54 )	E312011	10510	10177	
2 Fan ( 40, 48, 56, 64, 67 )	E312012	10510	10177	
3 Fan ( 47, 50, 59, 69, 81 )	E312252 and E312343	E312297	10177	E312608
3 Fan ( 60, 72, 85, 96, 99 )	E312344 and E312251	E312297	10177	E312608
4 Fan ( 62, 77, 93, 109 )	(2)E312343	E312297	E312297	E312608



# maintenance

Table 7 – 230 and 460 Volt Electric Defrost Heaters

Unit Size	Coil Heater ED Unit quantity	Coil Heater EDL Unit quantity	230/3/60 Coil Heater part number	460/3/60 Coil Heater part number	Drain Pan Heater quantity	230/3/60 Drain Pan Heater part number	460/3/60 Drain Pan Heater part number
09 6 ROW	6	9	E312491	E313973	3	21756	21762
09 8 ROW	9	12	E312491	E313973	3	21756	21762
18 6 ROW	12	18	E312491	E313973	6	21756	21762
18 8 ROW	18	24	E312491	E313973	6	21756	21762
20 6 ROW	9	12	E311562	E311099	3	E312205	E312206
20 8 ROW	12	15	E311562	E311099	3	E312205	E312206
24 6 ROW	12	15	E311562	E311099	3	E312205	E312206
24 8 ROW	15	21	E311562	E311099	3	E312205	E312206
28 6 ROW	15	18	E311562	E311099	3	E312205	E312206
28 8 ROW	18	24	E311562	E311099	3	E312205	E312206
32 6 ROW	21	24	E311562	E311099	3	E312205	E312206
32 8 ROW	24	30	E311562	E311099	3	E312205	E312206
33 6 ROW	18	24	17784	17781	6	21759	21765
33 8 ROW	24	30	17784	17781	6	21759	21765
39 6 ROW	24	30	17784	17781	6	21759	21765
39 8 ROW	30	42	17784	17781	6	21759	21765
40 6 ROW	18	24	E311562	E311099	6	21760	21766
40 8 ROW	24	30	E311562	E311099	6	21760	21766
46 6 ROW	30	36	17784	17781	6	21759	21765
46 8 ROW	36	48	17784	17781	6	21759	21765
48 6 ROW	24	30	E311562	E311099	6	21760	21766
48 8 ROW	30	42	E311562	E311099	6	21760	21766
50 6 ROW	18	24	17785	17782	6	21761	21767
50 8 ROW	24	30	17785	17782	6	21761	21767
54 6 ROW	42	48	17784	17781	6	21759	21765
54 8 ROW	48	60	17784	17781	6	21759	21765
56 6 ROW	30	36	E311562	E311099	6	21760	21766
56 8 ROW	36	48	E311562	E311099	6	21760	21766
59 6 ROW	24	30	17785	17782	6	21761	21767
59 8 ROW	30	42	17785	17782	6	21761	21767
64 6 ROW	42	48	E311562	E311099	6	21760	21766
64 8 ROW	48	60	E311562	E311099	6	21760	21766
69 6 ROW	30	36	17785	17782	6	21761	21767
69 8 ROW	36	48	17785	17782	6	21761	21767

Consult factory for heaters with voltages other than 230 or 460 volt.





# CF Series

USER MANUAL

---

**SPX COOLING TECHNOLOGIES, INC.**

827 WEST PROGRESS DRIVE  
DIXON, IL 61021 USA  
815 284 2700 | [spxcooling@spx.com](mailto:spxcooling@spx.com)  
[spxcooling.com](http://spxcooling.com)

E207093R1 | ISSUED 02/2020

© 2020 SPX COOLING TECHNOLOGIES, INC | ALL RIGHTS RESERVED

In the interest of technological progress, all products are subject to design and/or material change without notice.

