

Aquatower[®]

STEEL COOLING TOWER

engineering data
and specifications

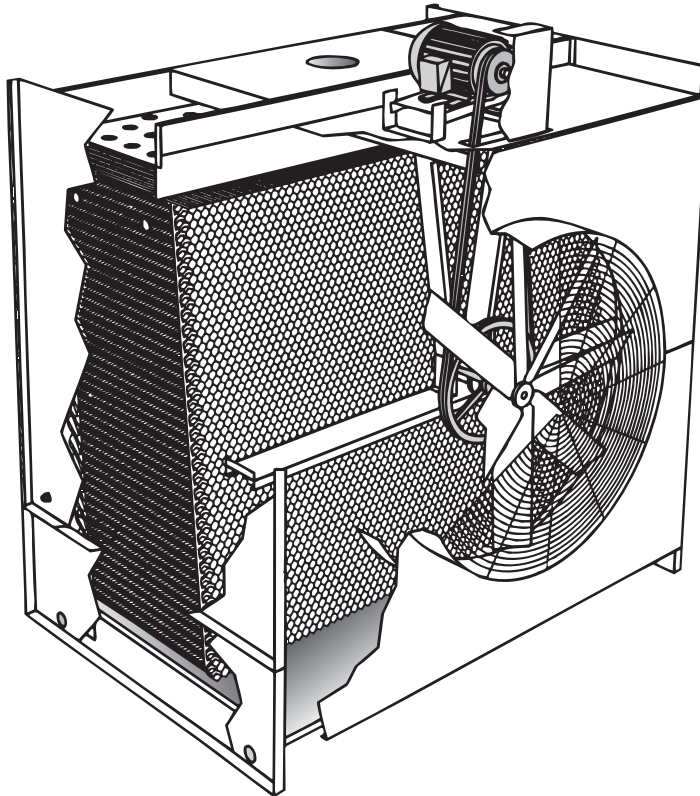



- **Proven Performance.** CTI Certified. Plus SPX stands by its responsibility for reliable thermal performance. We designed it. We rate it. We guarantee it!
- **Induced-Draft Design.** Save on fan power. The fan will operate in a warm atmosphere even in winter, so you'll never have to work on frozen mechanical equipment.
- **Crossflow Design.** Save on pump power because you only pay to move the water to the top of the tower. Gravity does the rest. The mechanical equipment and water distribution system are out where you can easily maintain them.
- **All-Season Reliability.** Aquatowers perform as specified in the heat of summer. They respond well to energy management techniques in the spring and fall and with appropriate fan controls, they can operate virtually ice-free in the dead of winter. Plus they offer simple maintenance all year long.
- **Proven Corrosion Protection.** Thousands of users over more than 65 years confirm the value of heavy galvanizing. And Marley's Z725 is the most effective galvanizing used in the industry.
- **PVC Film Fill with Integral Drift Eliminators and Louvers.** If you've ever had to replace deteriorated eliminators or louvers, you'll appreciate this advantage. Integral honeycomb louvers keep the circulating water inside your tower.
- **Select Your Aquatower on Our Website.** The Marley UPDATE web-based selection software—available at spxcooling.com/update—provides Aquatower model recommendations based on your specific design requirements
- **Simple, Flexible Installation.** Just mount the motor, belts and belt guard, install the outlet connection that suits your needs—both side suction and bottom outlet are provided, complete with screens—and adjust the float valve and your Aquatower is ready for operation.





Today's Aquatower may be the most space/energy-efficient cooling tower available. Your needs have dictated constant technological improvement. Thousands of Aquatower users enjoy the benefits of eight major redesigns and dozens of minor improvements in the past 65 years. For example, PVC film-fill enables the Aquatower to reject more heat per unit size. We also put the air inlet louvers and drift eliminators right on the fill sheets. This new arrangement saves you fan horsepower by improving airflow through the tower.

The Aquatower is a maintenance delight! You'll appreciate the way the Aquatower simplifies maintenance. No hidden spray systems, tiny nozzles, or enclosed basins here! You can easily replace and align V-belts from outside the tower.

All primary components of the Aquatower are open to view. You can easily remove any debris from the upper basin or nozzles while the tower is in operation.

Heavy mill galvanizing on all steel components prevents base metal corrosion. You won't have to worry about paint chips clogging your strainers and nozzles, because there is no paint to flake off. Heavy galvanizing also protects much better than paint.

You'll enjoy single source responsibility and reliability because we design and manufacture virtually all major cooling tower components.

All Marley components are designed and selected to be a part of an integrated system. For example, the spray pattern from nozzles and the pressure drop through drift eliminators both affect a fill's heat transfer capacity. So, we include that impact in our thermal analysis. Drift eliminators must be effective at the air velocities where fill is most efficient. So, we've carefully designed both components to work together efficiently.

How many other cooling tower companies can offer you this assurance? They may use one brand of nozzle with brand of fill and another manufacturer's drift eliminators. When they all come together, the whole may be less than the sum of the parts.

Our total system approach assures that all the parts work together to provide you the greatest total performance. And because we design specifically for cooling towers, all our components will provide many years of service with minimal maintenance.

Every Aquatower cooling tower carries a full one-year warranty. The Aquatower you buy from us will work on your job or we'll make it right. Your warranty includes thermal performance and every component of the tower. The SPX Cooling Technologies warranty is your assurance of performance—for a full year.

Above all, the Aquatower is readily available. You won't have to wait around—or accept second best—when you need a cooling tower. We maintain an impressive stock of completed towers at our own plants. A growing number of local distributors can draw from that stock.

Since 1947 the Marley Aquatower has inspired many imitators. Only SPX Cooling Technologies can offer you the original.

Contact your local distributor or Marley representative. They'll be glad to help you choose the proper model for your needs. They can also help you with your layout and piping.

MARLEY

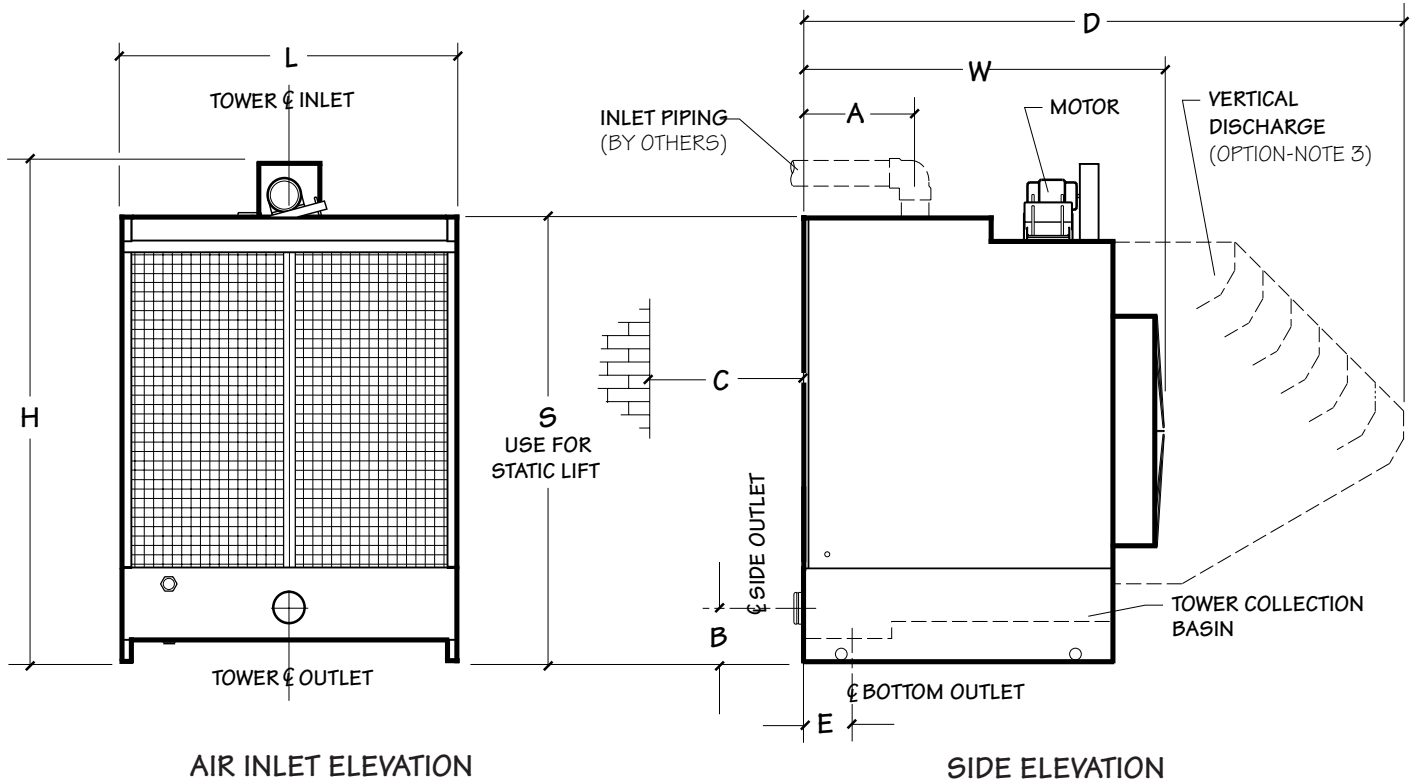

Tower Model	Nominal Tons note 1	Dimensions									Motor kW	Piping Connection	
		L	W	H	A	B	C note 2	D	E	S		Inlet	Outlet note 6
490A	8	902	1292	1610	402	175	610	note 3	note 6	1318	.25	2"	2" F
490D	10	902	1292	1610	402	175	610	note 3	note 6	1318	.75	2"	2" F
492D	22	1206	1543	2248	432	241	1219	note 3	203	1956	.75	4"	4" M
492G	28	1206	1543	2248	432	241	1219	note 3	203	1956	1.5	4"	4" M
493G	36	1816	1549	2248	432	241	1524	note 3	203	1956	1.5	4"	4" M
493H	42	1816	1549	2248	432	241	1524		203	1956	2.2	4"	4" M
494G	51	1816	1972	2743	608	292	1829	3251	235	2403	1.5	6"	6" MC
494H	57	1816	1972	2743	608	292	1829	3251	235	2403	2.2	6"	6" MC
494K	68	1816	1972	2743	608	292	1929	3251	235	2403	3.7	6"	6" MC
495K	80	2426	1975	2743	608	292	2134	3251	235	2403	3.7	6"	6" MC
495M	91	2426	1975	2743	608	292	2134	3251	235	2403	5.5	6"	6" MC
496K	111	3035	1984	2953	589	292	2743	3345	235	2610	3.7	6"	6" MC
496M	126	3035	1984	2953	589	292	2743	3345	235	2610	5.5	6"	6" MC

- Nominal tons are based upon 35°C HW, 29.5°C CW, 25.5°C WB and .68 m³/hr per ton. The Marley **UPDATE** web-based selection software provides Aquatower model recommendations based on specific design requirements.
- Minimum clearance for adequate air supply. Consult your Marley sales representative or your local distributor if this clearance is impractical for your job.
- Vertical discharge hood is for applications in restrictive enclosures or other locations where horizontal discharge is not desirable. CTI Certification does not apply when this option is selected. Available only on models 494 and larger.

- Motors are 400 volt, 3-phase TEFC.
- Motor, belt and belt guard ship uninstalled. Installation by others.
- Outlet sizes shown are side outlets. All models except 490A and 490D have connections for both side and bottom outlet. Install the desired connection and seal the unused opening with the coverplate provided. Pump suction should use side outlet. See page 9 for size and flow capacities of bottom outlets.
- Overflow is a 2" F connection located in side of collection basin.
- Drain is a 2" F connection located in collection basin floor.
- Makeup valve connection is 3/4" M located in tower side.

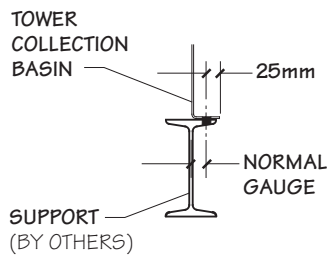
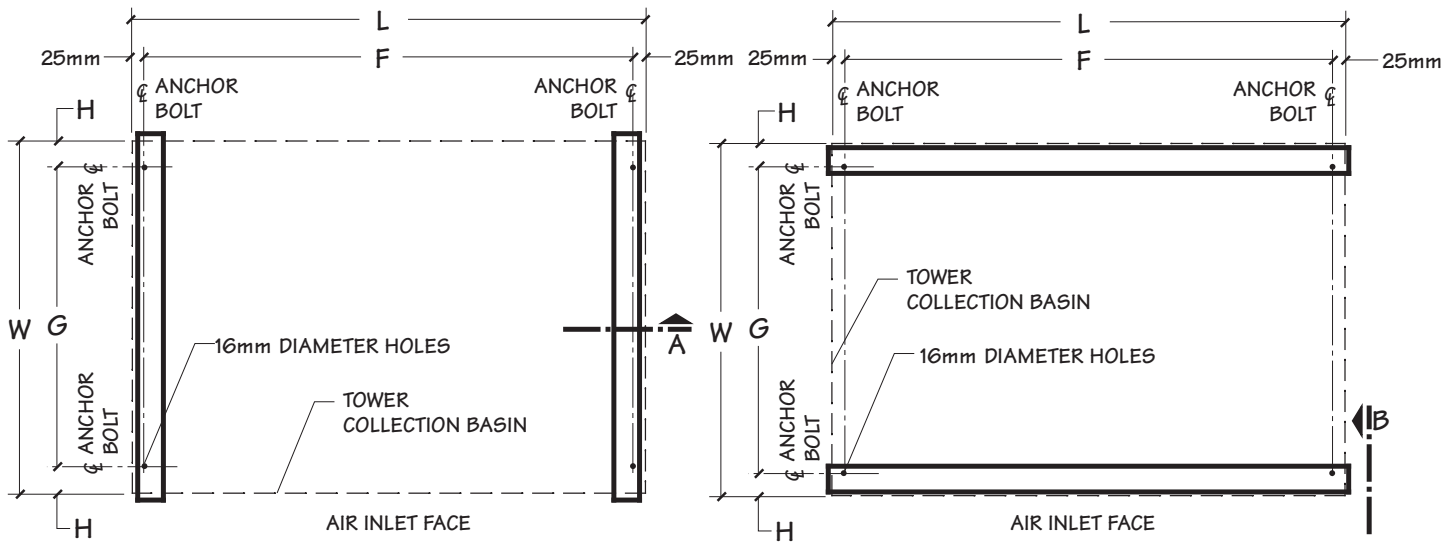

SECTION A

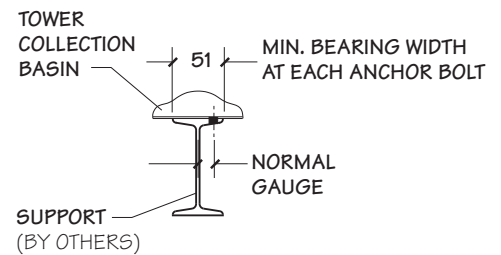

VIEW B

Tower Model	Dimensions					Shipping Weight kg	Maximum Operating kg	Maximum Operating Load at Anchor kg	Wind Load kg	
	L	W	F	G	H				Max. Vertical Reaction at Anchor	Max. Horizontal Reaction at Anchor
490	902	1019	851	915	52	198	343	84	82	52
492	1206	1260	1156	1067	97	337	633	158	161	95
493	1816	1206	1765	1067	97	445	905	226	238	129
494	1816	1680	1765	1524	78	634	1337	334	252	161
495	2426	1680	2375	1524	78	797	1294	437	338	213
496	3035	1680	2985	1524	78	951	2155	539	497	290
Models with Vertical Discharge Hood Option										
494	1816	1680	1765	1524	78	816	1519	380	316	234
495	2426	1680	2375	1524	78	968	1920	480	338	234
496	3035	1680	2985	1524	78	1178	2382	596	497	290

1. Use this bulletin for preliminary layouts only. Obtain current drawings from your Marley sales representative or your local distributor.
2. Purchaser to provide tower supports complete with holes and bolts for anchorage. All supports must be framed flush and level at top. Maximum deflection to be 1/360th of span, not to exceed 13mm.
3. Maximum weight occurs with basin full to overflow level at shutdown. Actual operating weight varies with flow and piping scheme.
4. Wind loads are based on 1.4 kPa and are additive to operating loads. Reactions due to wind loads exceed those resulting from seismic loads based on the 1997 UBC code, Zone 4 and an Importance Factor of 1.00 per Section 1634–Towers Not on a Building.

Use this data for preliminary layouts only. Obtain current drawing from your Marley sales representative.

UPDATE™ web-based selection software, available at spxcooling.com/update provides Aquatower model recommendations based on customer's specific design requirements.

WATER DISTRIBUTION SYSTEM

Warm water flows through external piping (not included with the tower) into a splash box at the top of the Aquatower. This splash box contains the incoming water and helps provide uniform water distribution. Water then flows by gravity from the basin through nozzles located over the fill. Hot water distribution basin covers are provided as standard equipment to keep the distribution basin free from airborne debris and to reduce the likelihood of biological growth.

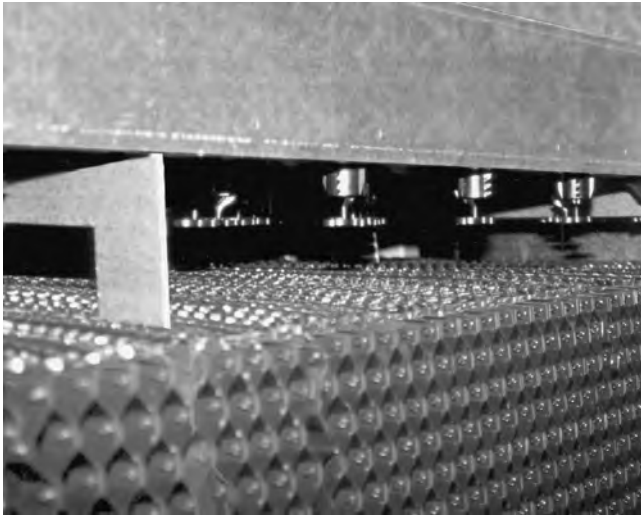

Eliminator air-seal removed showing nozzle distribution area above fill

All Aquatowers use Marley “Spiral Target” nozzles. These inert polypropylene nozzles are evenly spaced throughout the distribution basin to assure uniform water distribution over all portions of the fill. Their large openings resist clogging. Nozzles are easy to remove and replace if the design water flow rate needs to be changed.



Marley Spiral Target distribution nozzle

FILL/LOUVERS/DRIFT ELIMINATORS

Marley MX Fill features integral louvers and drift eliminators, designed to minimize resistance to airflow. This patented arrangement prevents water from escaping the fill, assuring proper heat transfer throughout wide variations in airflow. Users find MX fill operates ice-free even in extremely cold weather.

The thermoformed PVC fill sheets withstand hot water temperatures as high as 52°C. Fill sheets are immune to biological and corrosive decay and their flame spread rating is less than 25 per ASTM E-84. Galvanized structural tubes support and stabilize the fill. They also hold the bottom of the fill sheets above the cold water basin floor to simplify basin cleaning. Removable 25 x 25 mesh galvanized air inlet screens keep larger airborne trash out of the collection basin and fill area.

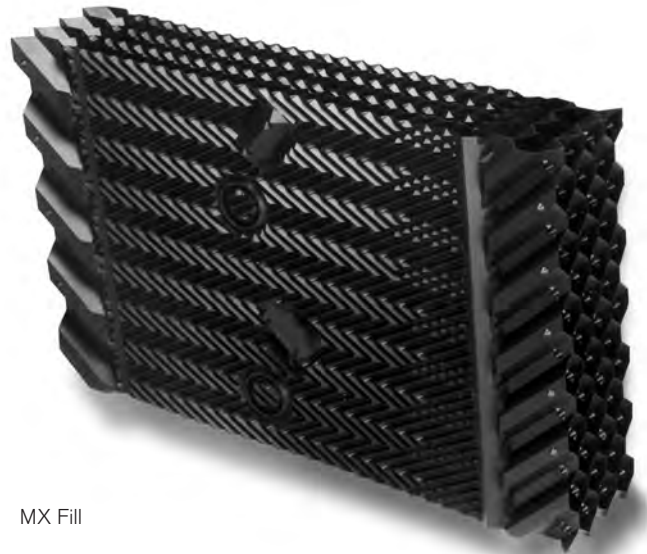

MX Fill

COLD WATER COLLECTION BASIN

The Aquatower’s collection basin simplifies basin cleaning, and assures proper outflow. Water flows from the elevated area under the fill into the basin’s rear depressed section, where side suction piping connects. A bottom outlet is also available for gravity flow applications.

Standard equipment on each tower basin includes: a screened suction connection; a threaded overflow connection, a threaded and plugged drain connection and a float-operated make-up valve. Models 492 through 496 also include a bottom outlet conforming to 125# flange specifications. A blank cover plate is provided to seal the outlet opening if not used.

MECHANICAL EQUIPMENT

Belt-drive propeller fans ensure design airflow at minimum horsepower. Fans are supported by a stainless steel fan shaft in a cast iron, oil-lubricated, tapered roller bearing assembly with remote oil reservoir. For ease of maintenance all drive components are accessible from outside the tower.

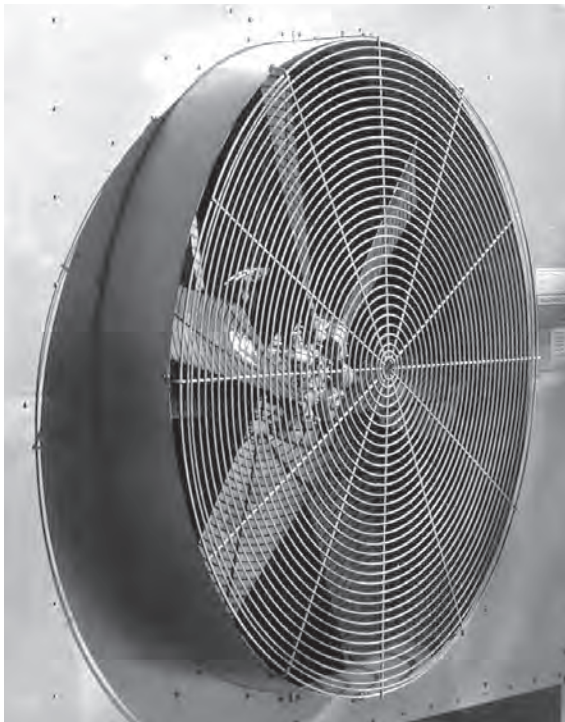

Fan guard is easily removed for access to fan and drive belts

Fan drive motors are TEFC designed specifically for cooling tower use. Standard motor horsepower appears in the table on page 4. Other types of motors are available. Typical options appear under Optional Accessories on page 10.

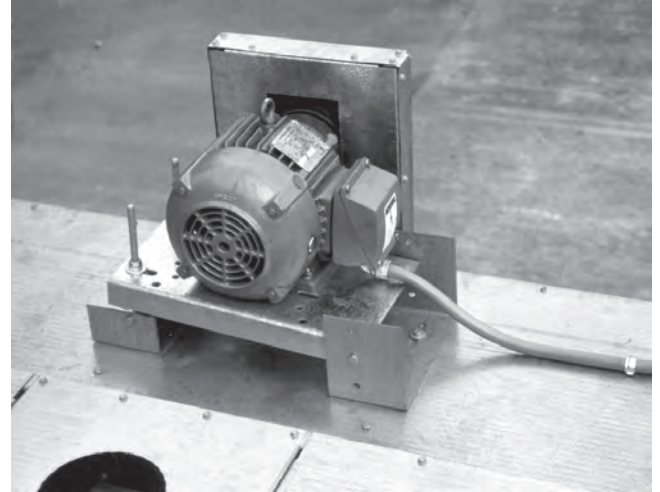

Fan drive motor showing adjustable base and belt guard

HOISTING AND HANDLING

Hoisting instructions on each tower explains how to use a spreader-bar and slings beneath the cold water basin floor to hoist the Aquatower. The tower's design also allows easy handling with a forklift.

SAFETY

Standard Aquatower safety features include fan guards and belt guards. Fan guards consist of welded heavy gauge steel wire hoops and spokes, hot dip galvanized after fabrication. The galvanized steel belt guard encloses both belts and pulleys. Guards are easily removed for servicing.

CONSTRUCTION AND FINISH

Aquatowers offer the corrosion protection of Z725 galvanized steel providing long term protection for the steel. Assembly hardware is also galvanized.

⚠ CAUTION

The cooling tower must be located at such distance and direction to avoid the possibility of contaminated discharge air being drawn into building fresh air intake ducts. The purchaser should obtain the services of a Licensed Professional Engineer or Registered Architect to certify that the location of the cooling tower is in compliance with applicable air pollution, fire and clean air codes.



When the ambient air temperature falls below 32°F, the water in a cooling tower can freeze. *Marley Technical Report #H-003 “Operating Cooling Towers in Freezing Weather”* describes how to prevent freezing during operation. Ask your Marley sales representative for a copy or download from our website.

Water collects in the cold water basin during shutdowns, and may freeze solid. You can prevent freezing by adding heat to the water left in the tower. Or, you can drain the tower and all exposed piping at shutdown.

ELECTRIC BASIN HEATERS

An electric immersion heater for each cell of the tower can be provided to prevent freezing of water in the collection basin during periods of shutdown. The rod type heater is installed in the side of the cold water basin.

Each heater will include an integral thermostat, set point nominally 4°C but adjustable to suit local operating requirements.

Any exposed piping that is still filled with water at shutdown – including the makeup water line—should be electrically traced and insulated (by others).

INDOOR TANK METHOD

With this system, water flows from an indoor tank, through the load system, and back to the tower, where it is cooled. The cooled water flows by gravity from the tower to the tank located in a heated space. At shutdown, all exposed water drains into the tank, where it is safe from freezing.

The table on page 9 lists typical drain-down capacities for all Aquatower models. Although we do not produce tanks, many of our representatives offer tanks supplied by reputable manufacturers.

The amount of water needed to successfully operate the system depends on the tower size, GPM and the volume of water contained in the piping system to and from the tower. You must select a tank large enough to contain those combined volumes—plus a level sufficient to maintain a flooded suction on your pump. Control makeup water according to the level where the tank stabilizes during operation.

You should always use a bottom outlet for this type of piping system. The table on page 9 lists the flow capacities for bottom outlets.

Basin Heater Selection		
Tower Model	-12°C Ambient	-25°C Ambient
490	3 kW	3 kW
492	3 kW	3 kW
493	3 kW	3 kW
494	3 kW	3 kW
495	3 kW	4.5 kW
496	4.5 kW	6 kW

1. Required kW is the amount of heat needed to maintain +5°C basin water temperature at the indicated ambient air temperature.
2. Heaters shown are 400 volts, three-phase. Options or special heater selections may add several weeks to delivery.
3. Heaters do not operate continuously. Heaters cycle on and off automatically as basin water temperature dictates.
4. Contact your Marley sales representative for selections appropriate for other ambient conditions than those shown here.

Drain-Down Capacity		
Tower Model	Range of Tower Design m ³ /hr	Maximum Drain-Down litres
490	3.4 - 5.9	106
	6.2 - 11.6	114
	11.8 - 19.3	125
	19.5 - 34.7	136
492	4.77 - 12	185
	12.6 - 209	204
	21 - 34.3	227
493	34.5 - 47.9	246
	7.5 - 18.8	291
	19 - 32.7	318
494	32.9 - 54	356
	54.2 - 74.5	382
	13.6 - 32	507
495	32.3 - 51.5	549
	51.7 - 85.4	613
	85.6 - 127.8	674
496	18.6 - 43.6	689
	43.8 - 61.3	727
	61.5 - 116.5	829
496	116.7 - 173.3	912
	23.6 - 44.5	863
	44.7 - 64.9	920
	65.1 - 112.8	1026
	113.1 - 218.7	1211

Volumes shown are maximums for the flow ranges indicated. Actual volumes will usually be less. Contact your local Marley sales representative for more specific information.

Bottom Outlet Maximum m ³ /hr				
Tower Model	Outlet Diameter			
	4"	6"	8"	10"
492	27	51	51	na
493	27	61	79	na
494	32	70	125	142
495	32	70	125	193
496	32	70	125	195

1. Maximum flow applies to both pump and gravity flow piping systems. The outlet piping on gravity flow systems must have sufficient vertical drop to overcome all other head losses in the system.
2. Bottom outlet is not available on 490 models.

FIELD ASSEMBLY

If you choose to assemble your Aquatower at the job site, your Aquatower will be shipped unassembled with complete assembly instructions.

The following table shows the sizes and weights of the largest Aquatower components for each model. You can use this information to plan your rigging and transportation needs.

Unassembled tower shipment may add 3 to 5 weeks to normal lead times. Your Marley sales representative will be glad to help you plan for your unique needs.

Component Sizes and Weights			
Tower Model	Component	Size mm	Weight kg
490	Collection Basin End	305 x 330 x 914	7
	Collection Basin Floor	76 x 762 x 813	11
	Front Panel	51 x 914 x 112	10
	Casing Panel	51 x 102 x 132	20
492	Distribution Basin	203 x 406 x 813	8
	Collection Basin End	356 x 406 x 122	11
	Collection Basin Floor	76 x 914 x 112	17
	Front Panel	51 x 122 x 173	24
493	Casing Panel	51 x 660 x 1600	16
	Distribution Basin	203 x 406 x 112	11
	Collection Basin End	356 x 406 x 183	17
	Collection Basin Floor	76 x 914 x 1727	26
494	Front Panel	51 x 940 x 183	16
	Casing	51 x 660 x 1600	16
	Distribution	203 x 406 x 173	17
	Collection Basin End	457 x 457 x 1829	22
495	Collection Basin Floor	102 x 864 x 1727	26
	Front Panel	51 x 1117 x 1829	19
	Casing Panel	51 x 1016 x 1930	29
	Distribution Basin	203 x 711 x 1727	24
496	Optional Discharge Side	51 x 1041 x 1956	17
	Optional Discharge Floor	229 x 1143 x 1727	21
	Collection Basin End	457 x 457 x 2438	29
	Collection Basin Floor	102 x 864 x 2338	34
496	Front Panel	51 x 1118 x 2438	26
	Casing	51 x 1016 x 1930	29
	Distribution Basin	203 x 711 x 2337	32
	Optional Discharge Side	51 x 1041 x 1956	17
496	Optional Discharge Floor	229 x 1143 x 1600	19
	Collection Basin End	457 x 457 x 3048	36
	Collection Basin Floor	102 x 864 x 2946	43
	Front Panel	51 x 1168 x 3048	33
496	Casing Panel	51 x 1016 x 2134	32
	Distribution Basin	203 x 711 x 2946	40
	Optional Discharge Side	51 x 1143 x 1956	17
	Optional Discharge Floor	229 x 1143 x 1956	25

OPTION	DESCRIPTION
Field Assembly	Where unique space restrictions or rigging conditions demand, Aquatowers can be shipped ready for field assembly by others. Complete step-by-step assembly instructions are provided.



Vertical Discharge Hood	<p>This option is available on Models 494A and larger. It provides vertical discharge of the air leaving the tower. Hoods are galvanized steel. They ship separately for installation by others. A large access door provides entry to the fan and mechanical equipment.</p> <p>For use in restrictive enclosures or other site situations where horizontal discharge is not desirable. CTI Certification does not apply when this option is selected.</p>
-------------------------	--

OPTION	DESCRIPTION
Stainless Steel Construction	All Aquatower models are available with stainless steel structure. Or you can choose a galvanized tower with a stainless steel cold water collection basin. Your Marley sales representative can help you choose the amount of corrosion resistance necessary for your installation.

Control System	Factory-installed control center in IP55, IEC enclosure mounted on tower casing. Complete with thermostat controller for single or two-speed motors to maintain chosen cold water temperature.
----------------	--

BASE: Furnish and install an induced-draft, crossflow, factory-assembled, steel cooling tower of ____ cell(s), as shown on plans. Tower shall be similar and equal in all respects to Marley Aquatower, Model _____. Tower must be warranted by the manufacturer for one year from date of shipment.

PERFORMANCE: Tower shall cool ____ m³/hr of water from ____ °C to ____ °C at a design entering air wet-bulb temperature of ____ °C and its thermal rating shall be certified by the Cooling Technology Institute.

CONSTRUCTION: Structural components of the tower, including the cold water basin, framework, mechanical equipment supports, casing, hot water basin, and fan cylinder shall be fabricated of heavy-gauge steel, protected against corrosion by Z725 galvanizing. All components subjected to factory welding shall be hot dip galvanized after fabrication. Cold galvanizing is not acceptable.

MOTOR: Motor(s) shall be ____ kW, Totally Enclosed, specially insulated for cooling tower duty. Speed and electrical characteristics shall be 1500 (or 1500/750) RPM, single-winding, ____ phase, ____ hertz, ____ volts. The motor must be located out of the saturated discharge air stream.

MECHANICAL EQUIPMENT: Fan(s) shall be adjustable-pitch propeller type. Fan shall be driven through V-belt(s) and protected with a belt guard. The fan and fan pulley shall be supported by oil lubricated tapered roller bearings in a cast iron housing with externally accessible remote oil reservoir for easy maintenance.

FILL, LOUVERS AND DRIFT ELIMINATOR: Fill shall be film-type, thermoformed PVC, with louvers and drift eliminator formed as part of each fill sheet. Fill shall be suspended from hot dip galvanized structural tubing supported from the upper tower structure, and shall be elevated above the floor of the cold water basin to facilitate cleaning. Air inlet faces of the tower shall be free of water splash-out. Guaranteed drift losses shall not exceed 0.005% of the design flow rate.

WATER DISTRIBUTION SYSTEM: An open basin above the fill bank shall receive hot water piped to each cell of the tower. The basins shall be equipped with removable covers to keep out debris. This basin shall be installed and sealed at the factory. Water shall enter the basin through a removable wave-suppressor splash box. The basin shall be no less than 162mm deep to provide adequate freeboard against overflow and splash-out. Removable and replaceable polypropylene nozzles installed in the floor of the basin shall provide full coverage of the fill by gravity flow. Nozzles must all have the same orifice size and be spaced symmetrically in both longitudinal and transverse directions.

COLD WATER BASIN AND ACCESSORIES: The cold water basin shall be factory sealed. For maximum installation flexibility, basin accessories shall include both a side suction connection and a hole and bolt circle in the basin floor suitable for gravity flow. Both connections shall include a debris screen and anti-cavitation device. A factory-installed, float-operated, mechanical makeup valve shall be included, having a ¾" diameter inlet connection.

SPX COOLING TECHNOLOGIES MALAYSIA SDN BHD

UNIT 505, BLOCK B, PHILEO DAMANSARA 2
NO. 15 JALAN 16/11 OFF JALAN DAMANSARA
46350 PETALING JAYA, MALAYSIA
60 3 7947 7800 | th.my.enquiry@spx.com
spxcooling.com

sea_AQ-13 | ISSUED 04/2016

COPYRIGHT © 2016 SPX CORPORATION

In the interest of technological progress, all products
are subject to design and/or material change without notice.

