

Cube DTC

EVAPORATIVE CONDENSER

engineering data
and specifications



Access Platforms

Condenser-supported mechanical access platforms are available on the condenser face where the mechanical access door is located. Platform surfaces are surrounded by a guardrail, kneerail and toeboard designed according to OSHA guidelines. Partial factory assembled platforms are available to simplify field installation. Available platform accessories include ladder(s), ladder extension(s), safety cage(s) and safety gate(s).

Remote Sump Application

For applications with remote sump, the condenser recirculating water pump and piping are removed and an outlet connection is added in the collection basin.

Belt Drive

The standard mechanical drive system consists of a Marley Geareducer coupled to a IEC premium efficiency, TEFC inverter duty motor. A drive system consisting of belts and pulleys may alternatively be selected based on user preference.

Vibration Switch

A mechanical vibration switch may be factory mounted for wiring to the shutdown circuit of the fan motor starter or VFD. The switch is designed to interrupt control power voltage to a safety circuit in the event of excessive vibration causing the starter or VFD equipment to de-energize the motor.

Quiet Fans

Standard low sound fans are designed to maximize air movement efficiency at low sound levels. Quiet fans provide lower sound levels with minimal cost impact by increasing blade count and/or reducing fan speed.

Ultra Quiet Fans

For applications requiring a significant reduction in condenser sound levels, Ultra Quiet fans may be employed to reduce above fan sound levels up to 16 dBA. Fans are propeller-type, incorporating wide-chord acoustic geometry, individually adjustable, corrosion and fire resistant marine grade aluminum blades resiliently mounted to an aluminum hub.

Lube Line and Dipstick

An external oil level dipstick can be selected on condensers with Geareducer drive.

Davit Crane

To simplify the removal of mechanical components, condenser-mounted portable davit cranes are available in 225 kg and 450 kg capacities.

Stainless Steel Construction

When an enhanced level of corrosion protection is desired, condensers may be configured with varying levels of stainless steel construction. Stainless steel collection basins, welded and factory water tested to reduce the potential for leaks, are a commonly selected upgrade. Units with stainless steel collection basin and casing are also available.

Electronic Water Level Control

An electronic water level control system consisting of a IP56 control panel, water level probes and probe stilling chamber may be selected to monitor the water level in the collection basin to determine level events used for makeup, high/low alarm(s), and/or pump shutdown.

Water Level Standpipe

An external water level standpipe is available to allow visual determination of the basin water level from the exterior of the unit while in operation.

Pump Heat Trace

When an electric basin heater package is selected, the recirculating pump(s) may be fitted with electric heat trace cable and insulated to protect the water retained in the pump from freezing during periods of shutdown or standby operation.

Basin Sweeper Piping

As an option to augment an external filtration system, the collection basin may be equipped with a factory installed corrosion resistant sweeper piping system designed to force dirt and debris towards a dedicated drain in the depressed section of the collection basin.

Splash Attenuation

Condensers may be selected with optional polypropylene splash attenuation media, factory installed in the collection basin to reduce falling water noise at the air inlet.

STRONG GALVANIZED STEEL CONSTRUCTION

The high quality mechanical components and refrigeration coils are safely housed in heavy-duty galvanized steel to ensure corrosion protection, low maintenance and long life. Submerged areas are bolted or welded to minimize potential for leaks; tap screws are not used in submerged areas.

STAINLESS STEEL OPTIONS

When environmental and design conditions dictate, heavy gauge stainless steel water collection basins and other structural components may be specified.

DUAL U-BOLT FAN HUB

The hub design reduces fan de-pitching and vibration potential.

CLOG-RESISTANT WATER DISTRIBUTION SYSTEM

Self-draining spray headers and large orifice spray nozzles help prevent debris build-up and clogging. Self-draining spray headers limit potential ice buildup when not operational; spray nozzles mount to the bottom of the spray pipes.

SOUND REDUCTION

Quiet operation is increasingly an important part of product specifications. Sound reduction options enable induced draft selections with sound levels up to 15+ dbA lower than similar steel forced draft condensers.

MARLEY GEAREDUCER® DRIVE

Genuine Marley mechanical system offers lowest maintenance costs and most reliable performance with 5-year warranty. Belt drive optional.

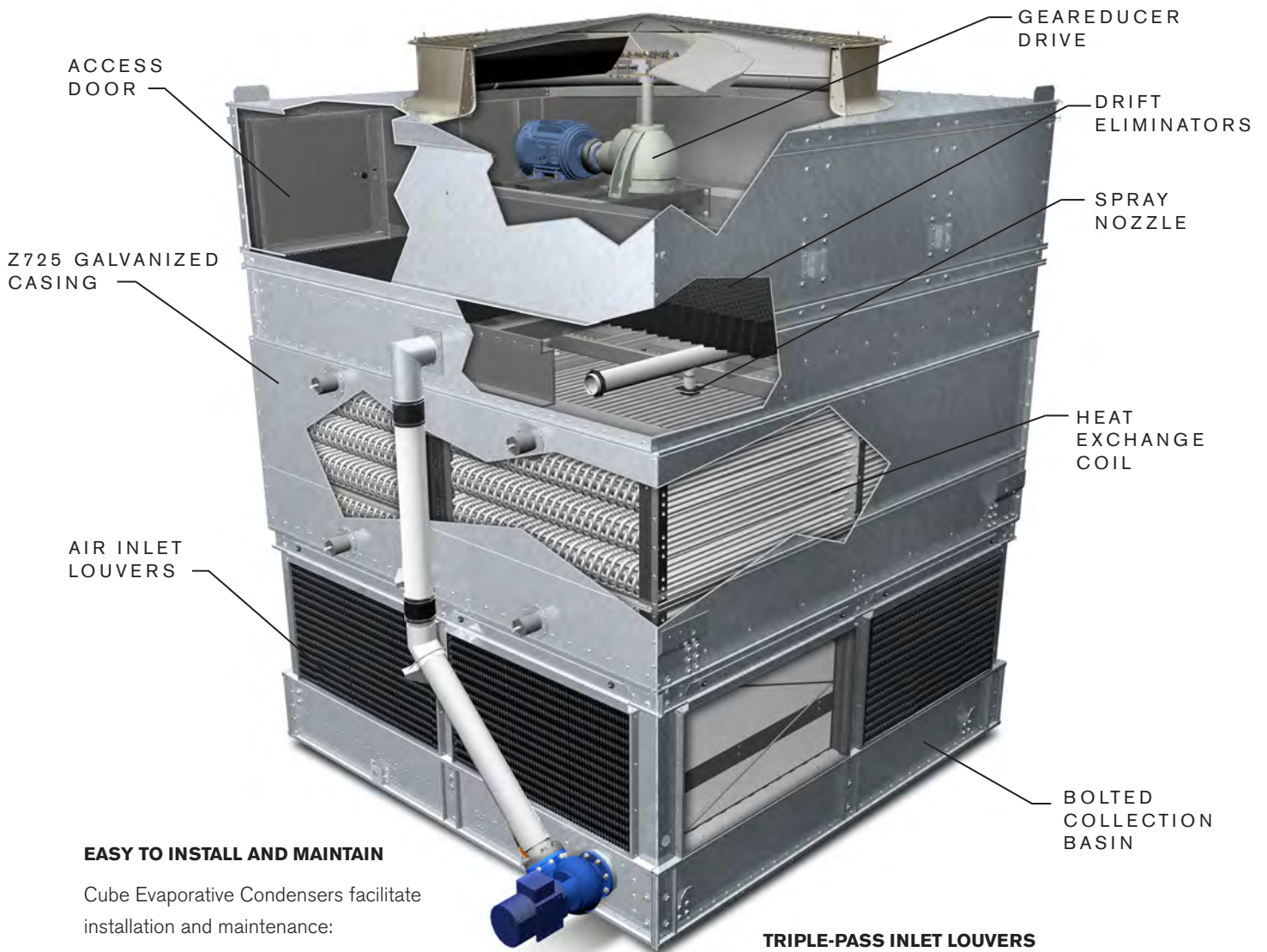

EASY TO INSTALL AND MAINTAIN

Cube Evaporative Condensers facilitate installation and maintenance:

- Module connections require minimal fasteners
- Pre-assembled platform options have welded guardrails

TRIPLE-PASS INLET LOUVERS

Removable louvers control splash-out and sunlight exposure to limit algae growth.

Condenser Recirculating Water

When the ambient air temperature falls below 0°C, the recirculating water within the condenser can freeze. *Marley Technical Report #H-003 "Cooling Towers and Freezing Weather"* describes how to prevent freezing during operation. Ask your sales representative for a copy or download a copy at spxcooling.com. During shutdown, water collects in the basin and may freeze solid. You can prevent freezing by adding heat to the water left in the basin or, you can drain the condenser basin and all exposed pipework at shutdown.

Remote Sump Application

With this type of system, recirculating water used by the condenser for evaporative heat rejection is pumped to the condenser spray system from a remote tank and flows by gravity from the condenser back to the tank. At shutdown, all exposed water drains into the tank, located in a heated space, where it is safe from freezing. The amount of water needed to successfully operate the system depends on condenser size and volume of water contained in the piping system to and from the condenser. Select a tank large enough to contain those combined volumes, plus a level sufficient to maintain a flooded suction on the pump. Control makeup water according to the level where the tank stabilizes during operation.

System Cleanliness

The Cube Evaporative Condenser can be a very effective air washer. Atmospheric dust and particulates able to pass through the relatively small louver or screen openings will enter the recirculating water system. Increased concentrations can intensify systems maintenance by clogging screens and strainers—and smaller particulates can coat system heat transfer surfaces. In areas of low flow velocity, such as the collection basin, sedimentary deposits can provide a breeding ground for bacteria. In areas prone to dust and particulates, consider installing some means for keeping the collection basin clean. Typical devices include basin sweeper piping in conjunction with side stream filters and a variety of filtration media.

Blowdown

Blowdown or bleed-off is the continuous removal of a small portion of the water from the open recirculating system. Blowdown is used to prevent the dissolved solids from concentrating to the point where they will form scale. The amount of blowdown required depends on the heat load and the composition of the makeup water. The Cube Condenser is equipped with a blowdown line with metering valve connected directly to the overflow. Specific blowdown adjustment instructions and additional blowdown information can be found in the applicable *Cube Condenser User Manual*.

Water Treatment

To control the buildup of dissolved solids resulting from water evaporation, as well as airborne impurities and biological contaminants including Legionella, an effective, consistent water treatment program is required. Simple blowdown may be adequate to control corrosion and scale, but biological contamination can only be controlled with biocides. An acceptable water treatment program must be compatible with the variety of materials incorporated in the condenser. Ideally the pH of the recirculating water should fall between 6.5 and 9.0. Batch feeding of the chemicals directly into the condenser is not recommended since localized damage is possible. Specific startup instructions and additional water quality recommendations can be found in the *Cube Condenser User Manual* which accompanies the condenser and also is available from your sales representative.

Air Circulation

Considering the air path entering and exiting the condenser is critical to ensure the condenser operates as designed. Obstructions near the air inlet(s) and discharge should be located a sufficient distance away so as not to impede airflow. If the condenser is to be located in an enclosure or near tall barriers, the air discharge should be positioned at an elevation higher than the top of the barriers to discourage recirculation of the hot discharge air. The condenser must be located at such distance and direction to avoid the possibility of contaminated discharge air being drawn into building fresh air intake ducts.

Piping

Always follow accepted engineering practices during design and installation of condenser piping. All piping must be supported independent of the condenser—no loads are to be supported by the condenser coil connections or condenser structure. Precautions must be taken to protect the condenser from excess heat generated during welding.

MODEL NOMENCLATURE

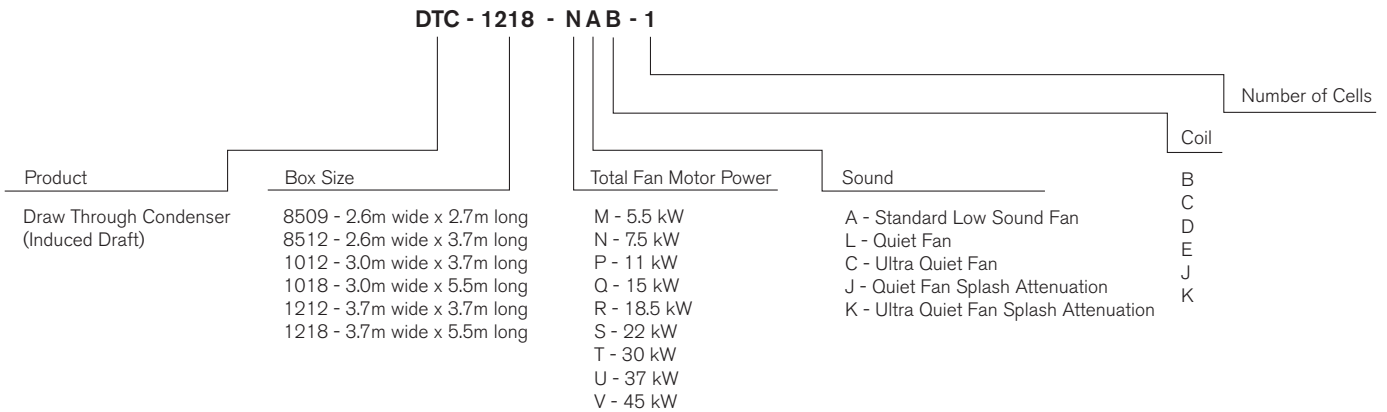

HEAT REJECTION METHOD

There are several commonly used methods for selecting an evaporative condenser as part of a mechanical refrigeration system. The most accurate method sizes a condenser based on the Total Heat Rejection required at a given condensing duty. Total Heat Rejection is defined as the sum of the heat input at the evaporator and the energy input at the compressor.

1. Establish the Design Duty

- a. Refrigerant
- b. Condensing Temperature - °C
- c. Wet-Bulb Temperature - °C
- d. Total Heat Rejection required - kW

Open Compressors:

$$THR (kW) = \text{Compressor Evaporator Capacity (kW)} + \text{Compressor Power (kW)}$$

Hermetic Compressors:

$$THR (kW) = \text{Compressor Evaporator Capacity (kW)} + \text{Compressor Input (kW)}$$

- Note:
- 1 MBH = 1000 Btu/hr
 - 1 Ton = 12 MBH
 - 1 kW = 3.415 MBH
 - 1 hp = 2.545 MBH
 - 1 kW = 1.341 hp
 - 1 °F = 1.8 °C + 32

2. Determine the Heat Rejection Capacity Factor

- a. Select the appropriate Heat Rejection Capacity Factor table based on the system Refrigerant.

- 1. **Table 2** – Ammonia R717
- 2. **Table 3** – HFC and HCFC

- b. Find the Heat Rejection Capacity Factor corresponding to the design Condensing Temperature and design Wet-Bulb Temperature.

3. Calculate the Corrected Heat Rejection

Multiply the Total Heat Rejection from **Step 1** by the Heat Rejection Capacity Factor from **Step 2** to obtain the Corrected Heat Rejection.

4. Select an Evaporative Condenser Model

Select an Evaporative Condenser model with a Base Heat Rejection **Table 1** greater than or equal to the Corrected Heat Rejection calculated in **Step 3**. If the Corrected Heat Rejection exceeds table values, multiple cells are required.

Model	Base Heat Rejection kW
DTC-8509-MAB1	822.6
DTC-8509-NAB1	869.4
DTC-8509-PAB1	954.9
DTC-8509-QAB1	996.0
DTC-8509-MAC1	896.1
DTC-8509-NAC1	950.7
DTC-8509-PAC1	1,046.1
DTC-8509-QAC1	1,093.7
DTC-8509-MAD1	951.2
DTC-8509-NAD1	1,012.2
DTC-8509-PAD1	1,121.6
DTC-8509-QAD1	1,168.1
DTC-8509-MAJ1	974.8
DTC-8509-NAJ1	1,033.1
DTC-8509-PAJ1	1,132.9
DTC-8509-QAJ1	1,180.0
DTC-8509-MAE1	999.0
DTC-8509-NAE1	1,067.4
DTC-8509-PAE1	1,181.1
DTC-8509-QAE1	1,237.5
DTC-8509-MAK1	1,013.7
DTC-8509-NAK1	1,081.8
DTC-8509-PAK1	1,194.5
DTC-8509-QAK1	1,246.1

Model	Base Heat Rejection kW
DTC-8512-NAB1	1,122.2
DTC-8512-PAB1	1,234.1
DTC-8512-QAB1	1,299.7
DTC-8512-RAB1	1,343.6
DTC-8512-NAC1	1,233.9
DTC-8512-PAC1	1,354.4
DTC-8512-QAC1	1,428.4
DTC-8512-RAC1	1,477.7
DTC-8512-NAD1	1,312.6
DTC-8512-PAD1	1,450.2
DTC-8512-QAD1	1,536.4
DTC-8512-RAD1	1,587.8
DTC-8512-SAD1	1,623.8
DTC-8512-NAJ1	1,341.0
DTC-8512-PAJ1	1,462.0
DTC-8512-QAJ1	1,537.1
DTC-8512-RAJ1	1,590.1
DTC-8512-SAJ1	1,618.4
DTC-8512-NAE1	1,379.8
DTC-8512-PAE1	1,526.1
DTC-8512-QAE1	1,613.4
DTC-8512-RAE1	1,669.3
DTC-8512-SAE1	1,723.7
DTC-8512-NAK1	1,387.7
DTC-8512-PAK1	1,540.8
DTC-8512-QAK1	1,620.2
DTC-8512-RAK1	1,671.5
DTC-8512-SAK1	1,705.8

Model	Base Heat Rejection kW
DTC-1012-NAB1	1,238.0
DTC-1012-PAB1	1,359.4
DTC-1012-QAB1	1,443.9
DTC-1012-RAB1	1,501.8
DTC-1012-NAC1	1,394.3
DTC-1012-PAC1	1,492.9
DTC-1012-QAC1	1,596.1
DTC-1012-RAC1	1,687.1
DTC-1012-NAD1	1,438.3
DTC-1012-PAD1	1,557.3
DTC-1012-QAD1	1,661.8
DTC-1012-RAD1	1,796.4
DTC-1012-SAD1	1,895.3
DTC-1012-NAJ1	1,520.4
DTC-1012-PAJ1	1,637.4
DTC-1012-QAJ1	1,745.2
DTC-1012-RAJ1	1,819.1
DTC-1012-SAJ1	1,917.7
DTC-1012-PAE1	1,679.3
DTC-1012-QAE1	1,799.7
DTC-1012-RAE1	1,889.2
DTC-1012-SAE1	1,963.2
DTC-1012-PAK1	1,709.3
DTC-1012-QAK1	1,827.9
DTC-1012-RAK1	1,913.9
DTC-1012-SAK1	1,984.5

Model	Base Heat Rejection kW
DTC-1212-NAB1	1,471.7
DTC-1212-PAB1	1,617.3
DTC-1212-QAB1	1,720.8
DTC-1212-RAB1	1,794.1
DTC-1212-SAB1	1,882.3
DTC-1212-NAC1	1,658.9
DTC-1212-PAC1	1,772.1
DTC-1212-QAC1	1,899.5
DTC-1212-RAC1	2,002.7
DTC-1212-SAC1	2,103.7
DTC-1212-NAD1	1,755.9
DTC-1212-PAD1	1,903.7
DTC-1212-QAD1	2,031.0
DTC-1212-RAD1	2,124.9
DTC-1212-SAD1	2,255.7
DTC-1212-PAJ1	1,922.3
DTC-1212-QAJ1	2,057.3
DTC-1212-RAJ1	2,172.7
DTC-1212-SAJ1	2,297.6
DTC-1212-TAJ1	2,427.5
DTC-1212-PAE1	1,948.3
DTC-1212-QAE1	2,075.1
DTC-1212-RAE1	2,188.1
DTC-1212-SAE1	2,298.9
DTC-1212-PAK1	1,976.3
DTC-1212-QAK1	2,134.3
DTC-1212-RAK1	2,245.5
DTC-1212-SAK1	2,348.6
DTC-1212-TAK1	2,518.6

Model	Base Heat Rejection kW
DTC-1018-NAB1	1,788.6
DTC-1018-PAB1	1,932.2
DTC-1018-QAB1	2,048.2
DTC-1018-RAB1	2,136.3
DTC-1018-SAB1	2,249.5
DTC-1018-NAC1	1,928.5
DTC-1018-PAC1	2,102.4
DTC-1018-QAC1	2,229.3
DTC-1018-RAC1	2,336.6
DTC-1018-SAC1	2,469.3
DTC-1018-NAD1	2,034.8
DTC-1018-PAD1	2,221.7
DTC-1018-QAD1	2,378.4
DTC-1018-RAD1	2,490.8
DTC-1018-SAD1	2,634.8
DTC-1018-TAD1	2,804.4
DTC-1018-PAJ1	2,296.1
DTC-1018-QAJ1	2,457.6
DTC-1018-RAJ1	2,576.3
DTC-1018-SAJ1	2,694.0
DTC-1018-TAJ1	2,846.2
DTC-1018-PAE1	2,327.1
DTC-1018-QAE1	2,502.8
DTC-1018-RAE1	2,625.3
DTC-1018-SAE1	2,783.7
DTC-1018-TAE1	2,963.0
DTC-1018-PAK1	2,367.9
DTC-1018-QAK1	2,555.1
DTC-1018-RAK1	2,687.5
DTC-1018-SAK1	2,831.3
DTC-1018-TAK1	2,995.2

Model	Base Heat Rejection kW
DTC-1218-PAB1	2,251.5
DTC-1218-QAB1	2,403.3
DTC-1218-RAB1	2,513.0
DTC-1218-SAB1	2,629.8
DTC-1218-PAC1	2,464.0
DTC-1218-QAC1	2,639.9
DTC-1218-RAC1	2,779.5
DTC-1218-SAC1	2,900.9
DTC-1218-PAD1	2,621.7
DTC-1218-QAD1	2,825.5
DTC-1218-RAD1	2,962.0
DTC-1218-SAD1	3,089.0
DTC-1218-TAD1	3,309.4
DTC-1218-UAD1	3,574.5
DTC-1218-QAJ1	2,893.6
DTC-1218-RAJ1	3,016.2
DTC-1218-SAJ1	3,177.6
DTC-1218-TAJ1	3,374.3
DTC-1218-UAJ1	3,522.4
DTC-1218-VAJ1	3,665.6
DTC-1218-QAE1	2,886.2
DTC-1218-RAE1	3,020.5
DTC-1218-SAE1	3,168.9
DTC-1218-TAE1	3,419.0
DTC-1218-UAE1	3,579.6
DTC-1218-QAK1	2,955.5
DTC-1218-RAK1	3,246.1
DTC-1218-SAK1	3,265.0
DTC-1218-TAK1	3,507.8
DTC-1218-UAK1	3,702.0
DTC-1218-VAK1	3,859.8

Table 1 Base Heat Rejection

Table data is per cell. For multiple cell selections, multiply Base Heat Rejection by number of cells.

Ammonia R717 Heat Rejection Capacity Factors																			
Condensing Pressure bar	Condensing Temperature °C	Entering Wet-Bulb Temperature °C																	
		15	16	17	18	19	20	21	22	23	24	25	26	27	28	29	30	31	32
R717																			
10.6	30	1.16	1.23	1.30	1.38	1.48	1.60	1.75	1.94	2.18	2.50	2.94	3.62	-	-	-	-	-	
11.0	31	1.08	1.13	1.19	1.27	1.35	1.45	1.56	1.71	1.89	2.12	2.43	2.87	3.52	-	-	-	-	
11.3	32	1.01	1.05	1.11	1.17	1.23	1.31	1.41	1.53	1.67	1.84	2.07	2.37	2.80	3.44	-	-	-	
11.7	33	0.94	0.98	1.03	1.08	1.14	1.20	1.28	1.38	1.49	1.63	1.80	2.02	2.31	2.73	3.35	-	-	
12.1	34	0.89	0.92	0.96	1.00	1.05	1.11	1.17	1.25	1.34	1.45	1.59	1.75	1.97	2.26	2.66	3.27	-	
12.5	35	0.83	0.86	0.90	0.94	0.98	1.03	1.08	1.15	1.22	1.31	1.42	1.55	1.71	1.92	2.20	2.60	3.19	
12.9	36	0.79	0.81	0.84	0.88	0.91	0.95	1.00	1.06	1.12	1.19	1.28	1.38	1.51	1.67	1.87	2.15	2.53	3.11
13.3	37	0.74	0.77	0.79	0.82	0.86	0.89	0.93	0.98	1.03	1.09	1.16	1.25	1.35	1.47	1.63	1.83	2.10	2.47
13.7	38	0.71	0.73	0.75	0.78	0.80	0.83	0.87	0.91	0.95	1.01	1.07	1.14	1.22	1.32	1.44	1.59	1.79	2.05
14.1	39	0.67	0.69	0.71	0.73	0.76	0.78	0.82	0.85	0.89	0.93	0.98	1.04	1.11	1.19	1.29	1.40	1.55	1.74
14.5	40	0.64	0.66	0.67	0.69	0.72	0.74	0.77	0.80	0.83	0.87	0.91	0.96	1.02	1.08	1.16	1.26	1.37	1.52
14.9	41	0.61	0.62	0.64	0.66	0.68	0.70	0.72	0.75	0.78	0.81	0.85	0.89	0.94	0.99	1.06	1.13	1.23	1.34
15.4	42	0.58	0.60	0.61	0.63	0.64	0.66	0.68	0.71	0.73	0.76	0.79	0.83	0.87	0.92	0.97	1.03	1.11	1.20
15.8	43	0.56	0.57	0.58	0.60	0.61	0.63	0.65	0.67	0.69	0.71	0.74	0.77	0.81	0.85	0.89	0.95	1.01	1.08
16.3	44	0.53	0.54	0.56	0.57	0.58	0.60	0.61	0.63	0.65	0.67	0.70	0.73	0.76	0.79	0.83	0.87	0.93	0.99
16.8	45	0.51	0.52	0.53	0.54	0.56	0.57	0.58	0.60	0.62	0.64	0.66	0.68	0.71	0.74	0.77	0.81	0.85	0.91

Table 2 Ammonia R717 Heat Rejection Capacity Factors

HFC and HCFC Heat Rejection Capacity Factors																				
Condensing Pressure bar		Condensing Temperature °C	Entering Wet-Bulb Temperature °C																	
R404A	R507A		15	16	17	18	19	20	21	22	23	24	25	26	27	28	29	30	31	32
13.3	13.6	30	1.30	1.37	1.45	1.54	1.65	1.79	1.95	2.16	2.43	2.78	3.28	4.03	-	-	-	-	-	
13.6	13.9	31	1.20	1.26	1.33	1.41	1.50	1.61	1.74	1.90	2.11	2.37	2.71	3.20	3.92	-	-	-	-	
14.0	14.3	32	1.12	1.17	1.23	1.30	1.38	1.47	1.57	1.70	1.86	2.05	2.31	2.64	3.12	3.83	-	-	-	
14.4	14.7	33	1.05	1.09	1.14	1.20	1.27	1.34	1.43	1.53	1.66	1.81	2.00	2.25	2.58	3.04	3.73	-	-	
14.8	15.1	34	0.99	1.02	1.07	1.12	1.17	1.24	1.31	1.39	1.50	1.62	1.77	1.95	2.19	2.51	2.96	3.64	-	
15.2	15.5	35	0.93	0.96	1.00	1.04	1.09	1.14	1.20	1.28	1.36	1.46	1.58	1.72	1.90	2.14	2.45	2.89	3.56	
15.6	15.9	36	0.88	0.91	0.94	0.98	1.02	1.06	1.12	1.18	1.25	1.33	1.42	1.54	1.68	1.86	2.09	2.39	2.83	3.47
16.0	16.4	37	0.83	0.86	0.88	0.92	0.95	0.99	1.04	1.09	1.15	1.22	1.29	1.39	1.50	1.64	1.81	2.04	2.34	2.76
16.4	16.8	38	0.79	0.81	0.84	0.86	0.89	0.93	0.97	1.01	1.06	1.12	1.19	1.26	1.36	1.47	1.60	1.77	1.99	2.29
16.9	17.2	39	0.75	0.77	0.79	0.82	0.84	0.87	0.91	0.95	0.99	1.04	1.09	1.16	1.23	1.32	1.43	1.56	1.73	1.95
17.3	17.7	40	0.71	0.73	0.75	0.77	0.80	0.82	0.85	0.89	0.92	0.97	1.01	1.07	1.13	1.21	1.29	1.40	1.53	1.69
17.7	18.1	41	0.68	0.69	0.71	0.73	0.75	0.78	0.80	0.83	0.87	0.90	0.94	0.99	1.04	1.11	1.18	1.26	1.37	1.49
18.2	18.6	42	0.65	0.66	0.68	0.70	0.72	0.74	0.76	0.79	0.81	0.85	0.88	0.92	0.97	1.02	1.08	1.15	1.24	1.34
18.6	19.1	43	0.62	0.63	0.65	0.66	0.68	0.70	0.72	0.74	0.77	0.80	0.83	0.86	0.90	0.95	1.00	1.06	1.13	1.21
19.1	19.5	44	0.59	0.61	0.62	0.63	0.65	0.67	0.68	0.70	0.73	0.75	0.78	0.81	0.84	0.88	0.92	0.97	1.03	1.10
19.6	20.0	45	0.57	0.58	0.59	0.60	0.62	0.63	0.65	0.67	0.69	0.71	0.73	0.76	0.79	0.82	0.86	0.90	0.95	1.01

Table 3 HFC and HCFC Heat Rejection Capacity Factors

EXAMPLE Evaporative Condenser Selection

Design Duty	
Refrigerant	Ammonia
Wet-Bulb Temperature	26°C
Condensing Temperature	35°C
Compressor Evaporator Capacity	1200 kW
Compressor Power	300 kW

Calculations	
Total Heat Rejection	1500 kW
Capacity Factor	1.55
Corrected Heat Rejection	2325 kW
Model Selection	DTC-1212-TAJ1

The **Total Heat Rejection**, THR, is calculated using the formula for open compressors. 1200 kW + 300 kW = 1500 kW.

Multiplying the **Total Heat Rejection** of 1500 kW by 1.55 yields a **Corrected Heat Rejection** of 2325 kW. **DTC-1212-TAJ1** is the smallest Model Selection with a Base Heat Rejection **Table 1** greater than 2325 kW.

From the **Ammonia** Refrigerant Capacity Factor **Table 2**, at a 26°C **Wet-Bulb Temperature** and a 35°C **Condensing Temperature**, the **Heat Rejection Capacity Factor** is 1.55.

2.6m x 2.7m Single Cell

Use this data for preliminary layouts only. Obtain current drawing from your sales representative.

UPDATE™ web-based selection software, available at spxcooling.com/update provides Cube model recommendations based on customer's specific design requirements.

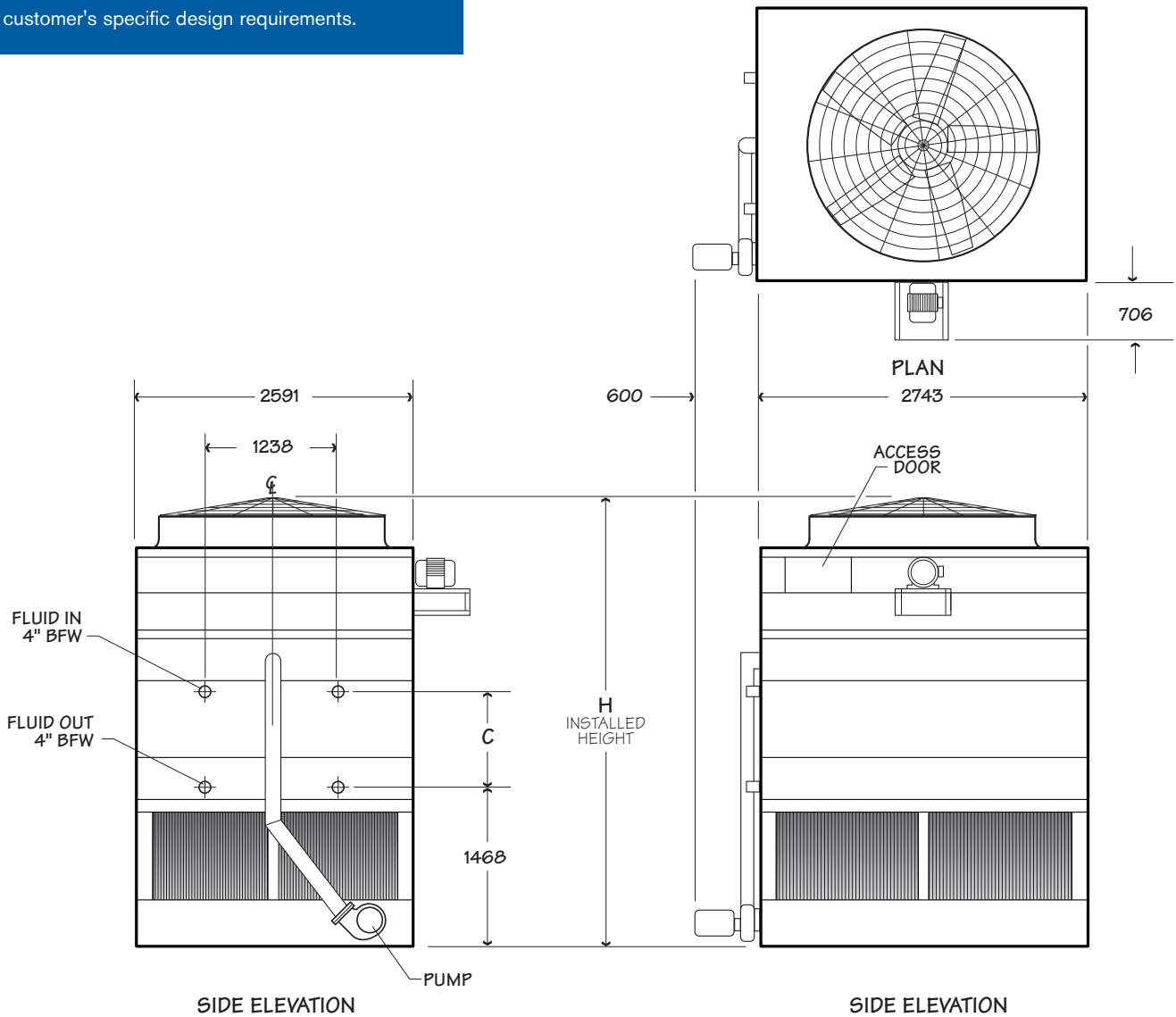

NOTE

1. The last digit of the model number shown represents the number of cells.
2. R717 tons are at 35.7°C condensing temperature, a -6.7°C suction temperature and a 25.6°C entering wet-bulb temperature.
3. For R134a charge, multiply by 1.98. For R22 charge multiply by 1.93. For R404A or R507A charge multiply by 1.65.
4. **Use this bulletin for preliminary layouts only.** Obtain current drawings from your sales representative.

Model note 1	Base Heat Rejection kW	R717 Capacity tons - note 2	Fan Motor kW	Airflow Rate m³/s	Shipping Weight kg		Design Operating Weight kg	Dimensions mm	
					Weight/Cell	Heaviest Section		H	C
DTC-8509-MAB1	822.6	136	5.5	18.5	4,130	3,450	5,310	3845	816
DTC-8509-NAB1	869.4	143	7.5	19.9	4,130	3,450	5,350		
DTC-8509-PAB1	954.9	157	11	22.0	4,220	3,490	5,400		
DTC-8509-QAB1	996.0	164	15	22.9	4,220	3,490	5,400	4075	9274
DTC-8509-MAC1	896.1	148	5.5	18.3	4,630	3,900	5,810		
DTC-8509-NAC1	950.7	157	7.5	19.7	4,630	3,900	5,850		
DTC-8509-PAC1	1,046.1	172	11	21.9	4,670	3,950	5,900		
DTC-8509-QAC1	1,093.7	180	15	22.8	4,670	3,990	5,900	4302	1273
DTC-8509-MAD1	951.2	157	5.5	18.1	5,080	4,350	6,310		
DTC-8509-NAD1	1,012.2	167	7.5	19.6	5,080	4,400	6,310		
DTC-8509-PAD1	1,121.6	185	11	21.8	5,130	4,450	6,400		
DTC-8509-QAD1	1,168.1	192	15	22.7	5,170	4,450	6,400		
DTC-8509-MAJ1	974.8	161	5.5	17.7	5,350	4,670	6,620		
DTC-8509-NAJ1	1,033.1	170	7.5	19.3	5,400	4,670	6,620		
DTC-8509-PAJ1	1,132.9	187	11	21.7	5,440	4,720	6,670		
DTC-8509-QAJ1	1,180.0	194	15	22.7	5,440	4,720	6,710	4531	1502
DTC-8509-MAE1	999.0	165	5.5	17.9	5,580	4,850	6,850		
DTC-8509-NAE1	1,067.4	176	7.5	19.4	5,580	4,900	6,850		
DTC-8509-PAE1	1,181.1	195	11	21.7	5,620	4,940	6,890		
DTC-8509-QAE1	1,237.5	204	15	22.6	5,670	4,940	6,940		
DTC-8509-MAK1	1,013.7	167	5.5	17.3	5,900	5,220	7,210		
DTC-8509-NAK1	1,081.8	178	7.5	19.0	5,940	5,220	7,210		
DTC-8509-PAK1	1,194.5	197	11	21.5	5,990	5,260	7,260		
DTC-8509-QAK1	1,246.1	205	15	22.5	5,990	5,260	7,260		

Model	R717 Charge kg - note 3	Internal Coil Volume L	Pump Motor kW	Recirculating Flow Rate L/s	Remote Sump Application		
					Approximate Operating Weight kg	Bottom Outlet Diameter	Volume L
DTC-8509-MAB1	103	651	1.5	22.4	4,990	8"	830
DTC-8509-NAB1	103	651			5,030		
DTC-8509-PAB1	103	651			5,080		
DTC-8509-QAB1	103	651			5,080		
DTC-8509-MAC1	126	801			5,490		
DTC-8509-NAC1	126	801			5,530		
DTC-8509-PAC1	126	801			5,580		
DTC-8509-QAC1	126	801			5,580		
DTC-8509-MAD1	152	951			5,990		
DTC-8509-NAD1	152	951			5,990		
DTC-8509-PAD1	152	951			6,080		
DTC-8509-QAD1	152	951			6,080		
DTC-8509-MAJ1	166	1,050			6,310		
DTC-8509-NAJ1	166	1,050			6,310		
DTC-8509-PAJ1	166	1,050			6,350		
DTC-8509-QAJ1	166	1,050			6,400		
DTC-8509-MAE1	175	1,101			6,530		
DTC-8509-NAE1	175	1,101			6,530		
DTC-8509-PAE1	175	1,101			6,580		
DTC-8509-QAE1	175	1,101			6,620		
DTC-8509-MAK1	193	1,217	6,890				
DTC-8509-NAK1	193	1,217	6,890				
DTC-8509-PAK1	193	1,217	6,940				
DTC-8509-QAK1	193	1,217	6,940				

2.6m x 2.7m Single Cell

2.6m x 3.7m Single Cell

Use this data for preliminary layouts only. Obtain current drawing from your sales representative.

UPDATE™ web-based selection software, available at spxcooling.com/update provides Cube model recommendations based on customer's specific design requirements.

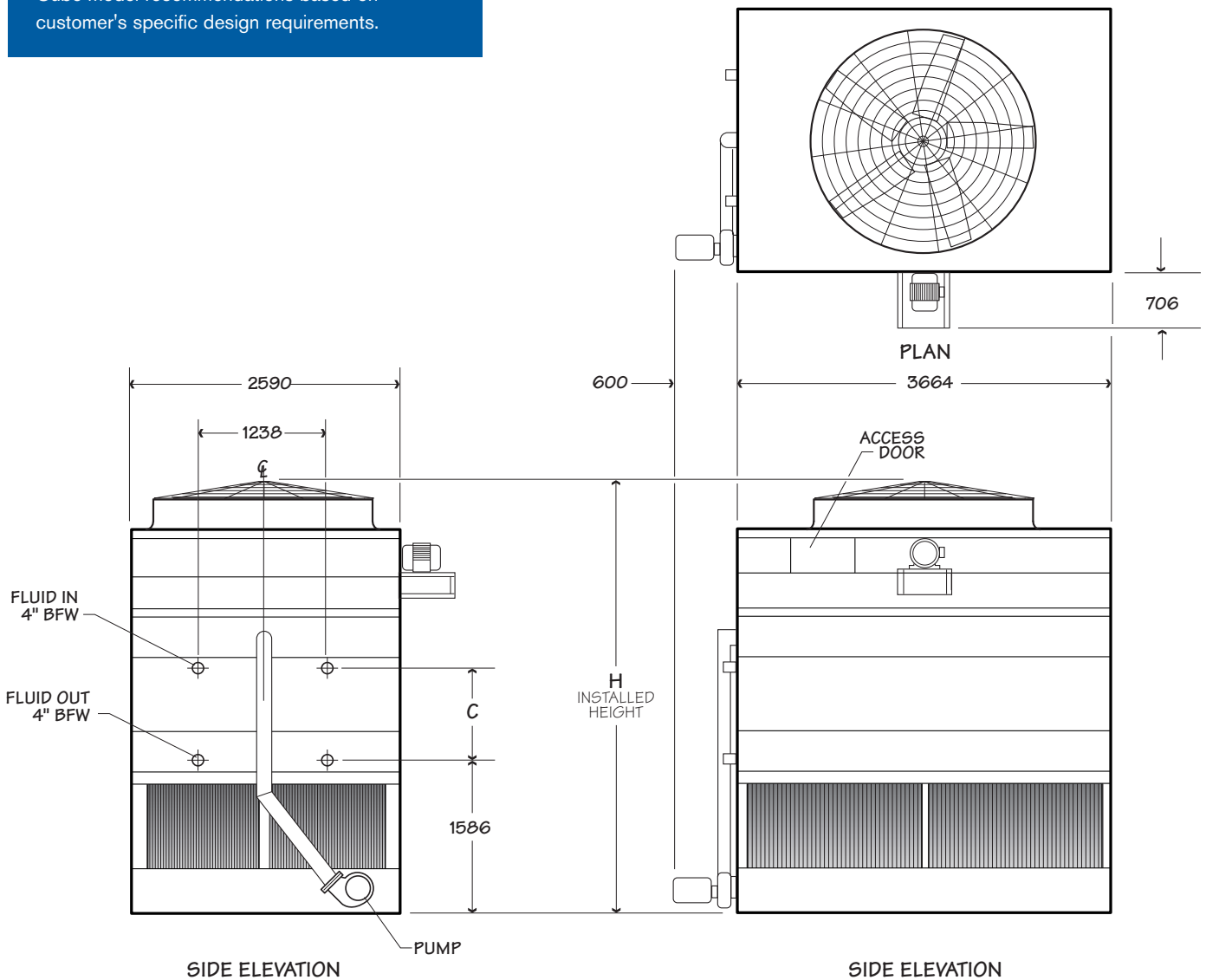

NOTE

1. The last digit of the model number shown represents the number of cells.
2. R717 tons are at 35.7°C condensing temperature, a -6.7°C suction temperature and a 25.6°C entering wet-bulb temperature.
3. For R134a charge, multiply by 1.98. For R22 charge multiply by 1.93. For R404A or R507A charge multiply by 1.65.
4. **Use this bulletin for preliminary layouts only.** Obtain current drawings from your sales representative.

Model note 1	Base Heat Rejection kW	R717 Capacity tons - note 2	Fan Motor kW	Airflow Rate m ³ /s	Shipping Weight lb		Design Operating Weight kg	Dimensions mm	
					Weight/Cell	Heaviest Section		H	C
DTC-8512-NAB1	1,122.2	185	7.5	24.1	4,940	4,080	6,530	3962	816
DTC-8512-PAB1	1,234.1	203	11	27.0	4,990	4,130	6,580		
DTC-8512-QAB1	1,299.7	214	15	28.5	4,990	4,130	6,620		
DTC-8512-RAB1	1,343.6	221	18.5	29.5	5,080	4,220	6,670		
DTC-8512-NAC1	1,233.9	203	7.5	23.9	5,530	4,670	7,170	4191	1045
DTC-8512-PAC1	1,354.4	223	11	26.9	5,580	4,720	7,210		
DTC-8512-QAC1	1,428.4	235	15	28.4	5,620	4,760	7,260		
DTC-8512-RAC1	1,477.7	243	18.5	29.3	5,670	4,810	7,300		
DTC-8512-NAD1	1,312.6	216	7.5	23.7	6,120	5,260	7,800	4420	1273
DTC-8512-PAD1	1,450.2	239	11	26.7	6,210	5,350	7,850		
DTC-8512-QAD1	1,536.4	253	15	28.3	6,210	5,350	7,890		
DTC-8512-RAD1	1,587.8	262	18.5	29.2	6,310	5,440	7,940		
DTC-8512-SAD1	1,623.8	268	22	29.9	6,310	5,440	7,980		
DTC-8512-NAJ1	1,341.0	221	7.5	23.4	6,530	5,670	8,210		
DTC-8512-PAJ1	1,462.0	241	11	26.3	6,580	5,720	8,260		
DTC-8512-QAJ1	1,537.1	253	15	28.0	6,580	5,720	8,260		
DTC-8512-RAJ1	1,590.1	262	18.5	29.1	6,670	5,810	8,350		
DTC-8512-SAJ1	1,618.4	267	22	29.8	6,670	5,810	8,350		
DTC-8512-NAE1	1,379.8	227	7.5	23.4	6,760	5,900	8,480		
DTC-8512-PAE1	1,526.1	251	11	26.6	6,850	5,990	8,530		
DTC-8512-QAE1	1,613.4	266	15	28.2	6,850	5,990	8,530		
DTC-8512-RAE1	1,669.3	275	18.5	29.1	6,940	6,080	8,620		
DTC-8512-SAE1	1,723.7	284	22	29.9	6,940	6,080	8,620		
DTC-8512-NAK1	1,387.7	229	7.5	22.7	7,210	6,350	8,940		
DTC-8512-PAK1	1,540.8	254	11	26.1	7,260	6,400	8,980		
DTC-8512-QAK1	1,620.2	267	15	27.8	7,260	6,400	8,980		
DTC-8512-RAK1	1,671.5	275	18.5	28.8	7,350	6,490	9,070		
DTC-8512-SAK1	1,705.8	281	22	29.6	7,350	6,490	9,070		

Model	R717 Charge kg - note 3	Internal Coil Volume L	Pump Motor kW	Recirculating Flow Rate L/S	Remote Sump Application		
					Approximate Operating Weight kg	Bottom Outlet Diameter	Volume L
DTC-8512-NAB1	139	865	2.2	33.4	6,030	8"	1,020
DTC-8512-PAB1	139	865			6,080		
DTC-8512-QAB1	139	865			6,120		
DTC-8512-RAB1	139	865			6,170		
DTC-8512-NAC1	171	1,068			6,670		
DTC-8512-PAC1	171	1,068			6,710		
DTC-8512-QAC1	171	1,068			6,760		
DTC-8512-RAC1	171	1,068			6,800		
DTC-8512-NAD1	202	1,272			7,300		
DTC-8512-PAD1	202	1,272			7,350		
DTC-8512-QAD1	202	1,272			7,390		
DTC-8512-RAD1	202	1,272			7,440		
DTC-8512-SAD1	202	1,272			7,480		
DTC-8512-NAJ1	224	1,406			7,710		
DTC-8512-PAJ1	224	1,406			7,760		
DTC-8512-QAJ1	224	1,406			7,760		
DTC-8512-RAJ1	224	1,406			7,850		
DTC-8512-SAJ1	224	1,406			7,850		
DTC-8512-NAE1	233	1,475			7,980		
DTC-8512-PAE1	233	1,475			8,030		
DTC-8512-QAE1	233	1,475			8,030		
DTC-8512-RAE1	233	1,475			8,120		
DTC-8512-SAE1	233	1,475			8,120		
DTC-8512-NAK1	260	1,632			8,440		
DTC-8512-PAK1	260	1,632			8,480		
DTC-8512-QAK1	260	1,632			8,480		
DTC-8512-RAK1	260	1,632			8,570		
DTC-8512-SAK1	260	1,632			8,570		

2.6m x 3.7m Single Cell

3.0m x 3.7m Single Cell

Use this data for preliminary layouts only. Obtain current drawing from your sales representative.

UPDATE™ web-based selection software, available at spxcooling.com/update provides Cube model recommendations based on customer's specific design requirements.

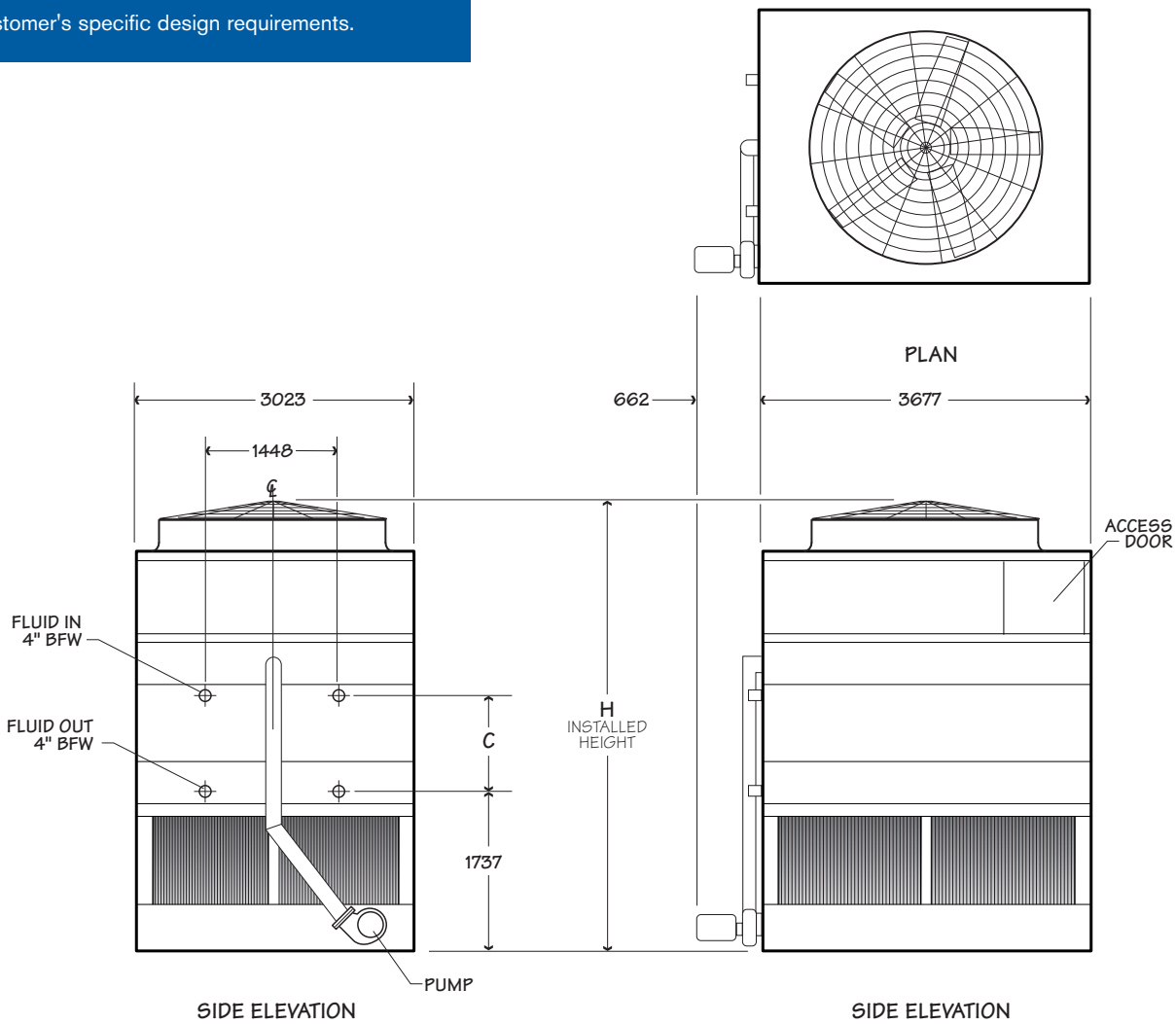

NOTE

1. The last digit of the model number shown represents the number of cells.
2. R717 tons are at 35.7°C condensing temperature, a -6.7°C suction temperature and a 25.6°C entering wet-bulb temperature.
3. For R134a charge, multiply by 1.98. For R22 charge multiply by 1.93. For R404A or R507A charge multiply by 1.65.
4. **Use this bulletin for preliminary layouts only.** Obtain current drawings from your sales representative.

Model note 1	Base Heat Rejection kW	R717 Capacity tons - note 2	Fan Motor kW	Airflow Rate m³/s	Shipping Weight kg		Design Operating Weight kg	Dimensions mm			
					Weight/Cell	Heaviest Section		H	C		
DTC-1012-NAB1	1,238.0	204	7.5	26.2	6,170	5,170	8,530	4634	816		
DTC-1012-PAB1	1,359.4	224	11	28.7	6,210	5,220	8,570				
DTC-1012-QAB1	1,443.9	238	15	30.9	6,210	5,220	8,620				
DTC-1012-RAB1	1,501.8	247	18.5	32.5	6,310	5,310	8,660				
DTC-1012-NAC1	1,394.3	230	7.5	25.8	6,890	5,900	9,300	4863	10456		
DTC-1012-PAC1	1,492.9	246	11	28.4	6,940	5,940	9,390				
DTC-1012-QAC1	1,596.1	263	15	30.7	6,940	5,940	9,390				
DTC-1012-RAC1	1,687.1	278	18.5	32.3	7,030	6,030	9,430				
DTC-1012-NAD1	1,438.3	237	7.5	25.5	7,620	5,350	10,120	5091	1273		
DTC-1012-PAD1	1,557.3	257	11	28.1	7,670	5,350	10,160				
DTC-1012-QAD1	1,661.8	274	15	30.5	7,670	5,350	10,160				
DTC-1012-RAD1	1,796.4	296	18.5	32.1	7,760	5,350	10,250				
DTC-1012-SAD1	1,895.3	312	22	34.4	7,760	5,350	10,250				
DTC-1012-NAJ1	1,520.4	251	7.5	24.7	8,070	5,810	10,570				
DTC-1012-PAJ1	1,637.4	270	11	27.5	8,120	5,810	10,660				
DTC-1012-QAJ1	1,745.2	288	15	30.1	8,120	5,810	10,660				
DTC-1012-RAJ1	1,819.1	300	18.5	31.8	8,210	5,810	10,750				
DTC-1012-SAJ1	1,917.7	316	22	34.3	8,210	5,810	10,750				
DTC-1012-PAE1	1,679.3	277	11	27.8	8,440	6,080	10,980			5320	1502
DTC-1012-QAE1	1,799.7	297	15	30.3	8,440	6,080	10,980				
DTC-1012-RAE1	1,889.2	311	18.5	32.0	8,530	6,080	11,070				
DTC-1012-SAE1	1,963.2	323	22	34.2	8,530	6,080	11,070				
DTC-1012-PAK1	1,709.3	282	11	27.0	8,940	6,620	11,570				
DTC-1012-QAK1	1,827.9	301	15	29.6	8,980	6,620	11,570				
DTC-1012-RAK1	1,913.9	315	18.5	31.5	9,030	6,620	11,610				
DTC-1012-SAK1	1,984.5	327	22	34.0	9,070	6,620	11,660				

Model	R717 Charge kg - note 3	Internal Coil Volume L	Pump Motor kW	Recirculating Flow Rate L/S	Remote Sump Application		
					Approximate Operating Weight kg	Bottom Outlet Diameter	Volume L
DTC-1012-NAB1	163	1,031	3.7	37.9	7,980	8"	1,290
DTC-1012-PAB1	163	1,031			8,030		
DTC-1012-QAB1	163	1,031			8,030		
DTC-1012-RAB1	163	1,031			8,120		
DTC-1012-NAC1	201	1,274			8,750		
DTC-1012-PAC1	201	1,274			8,800		
DTC-1012-QAC1	201	1,274			8,850		
DTC-1012-RAC1	201	1,274			8,890		
DTC-1012-NAD1	240	1,517			9,530		
DTC-1012-PAD1	240	1,517			9,620		
DTC-1012-QAD1	240	1,517			9,620		
DTC-1012-RAD1	240	1,517			9,660		
DTC-1012-SAD1	240	1,517			9,710		
DTC-1012-NAJ1	267	1,685			10,020		
DTC-1012-PAJ1	267	1,685			10,070		
DTC-1012-QAJ1	267	1,685			10,120		
DTC-1012-RAJ1	267	1,685			10,160		
DTC-1012-SAJ1	267	1,685			10,210		
DTC-1012-PAE1	279	1,760			10,430		
DTC-1012-QAE1	279	1,760			10,430		
DTC-1012-RAE1	279	1,760	10,520				
DTC-1012-SAE1	279	1,760	10,520				
DTC-1012-PAK1	310	1,956	10,980				
DTC-1012-QAK1	310	1,956	11,020				
DTC-1012-RAK1	310	1,956	11,070				
DTC-1012-SAK1	310	1,956	11,110				

3.0m x 3.7m Single Cell

3.7m x 3.7m Single Cell

Use this data for preliminary layouts only. Obtain current drawing from your sales representative.

UPDATE™ web-based selection software, available at spxcooling.com/update provides Cube model recommendations based on customer's specific design requirements.

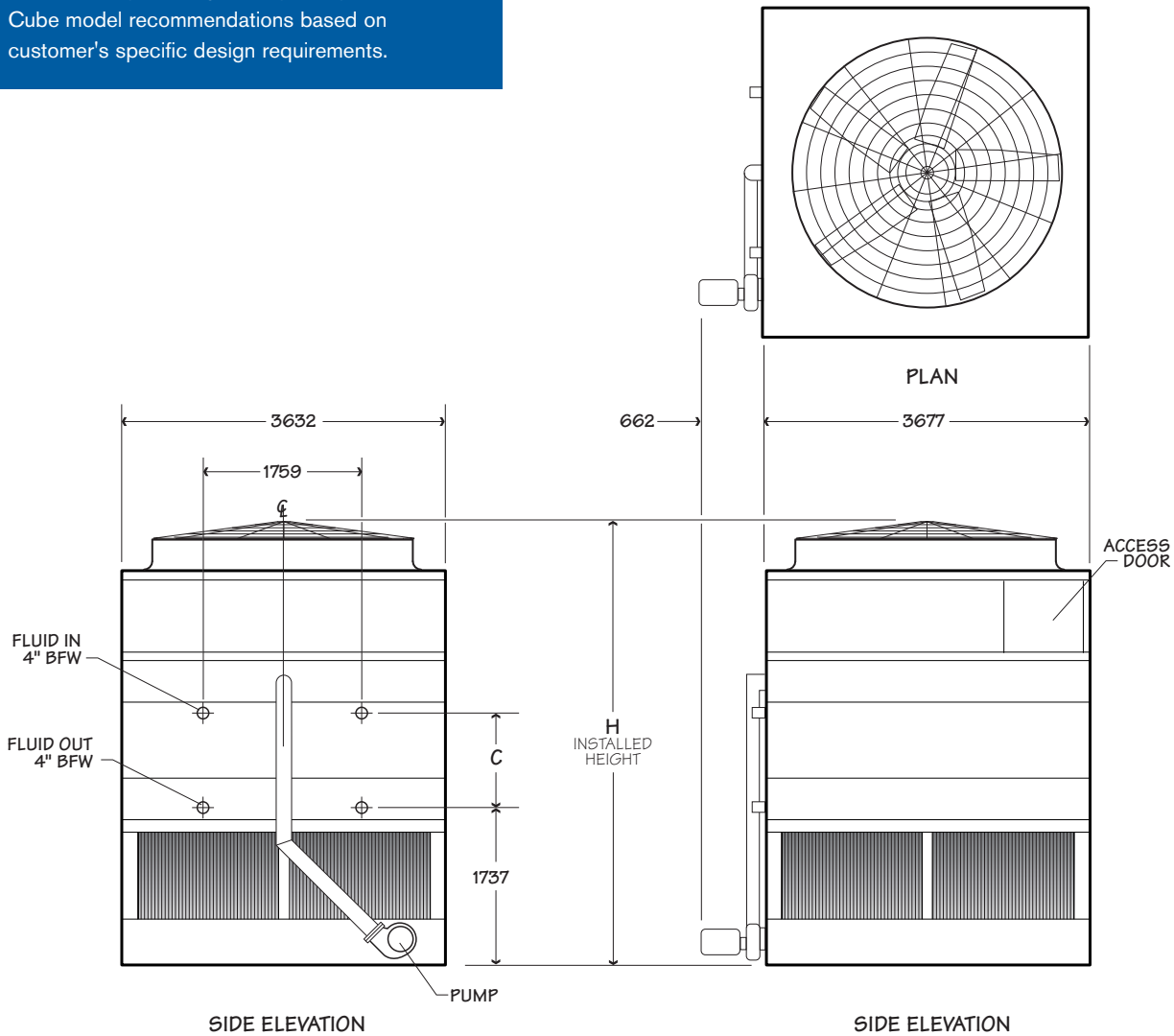

NOTE

1. The last digit of the model number shown represents the number of cells.
2. R717 tons are at 35.7°C condensing temperature, a -6.7°C suction temperature and a 25.6°C entering wet-bulb temperature.
3. For R134a charge, multiply by 1.98. For R22 charge multiply by 1.93. For R404A or R507A charge multiply by 1.65.
4. **Use this bulletin for preliminary layouts only.** Obtain current drawings from your sales representative.

Model note1	Base Heat Rejection kW	R717 Capacity tons - note 2	Fan Motor kW	Airflow Rate m³/s	Shipping Weight kg		Design Operating Weight kg	Dimensions mm	
					Weight/Cell	Heaviest Section		H	C
DTC-1212-NAB1	1,471.7	243	7.5	30.8	6,990	5,400	9,930	4634	816
DTC-1212-PAB1	1,617.3	267	11	34.2	7,080	5,440	9,980		
DTC-1212-QAB1	1,720.8	284	15	37.0	7,080	5,490	9,980		
DTC-1212-RAB1	1,794.1	296	18.5	39.0	7,170	5,530	10,070		
DTC-1212-SAB1	1,882.3	310	22	41.4	7,170	5,580	10,070	4863	1045
DTC-1212-NAC1	1,658.9	273	7.5	30.4	7,850	6,120	10,890		
DTC-1212-PAC1	1,772.1	292	11	33.9	7,940	6,210	10,930		
DTC-1212-QAC1	1,899.5	313	15	36.7	7,940	6,210	10,930		
DTC-1212-RAC1	2,002.7	330	18.5	38.7	7,980	6,310	11,020	5091	1273
DTC-1212-SAC1	2,103.7	347	22	41.2	8,030	6,310	11,020		
DTC-1212-NAD1	1,755.9	289	7.5	30.0	8,710	5,530	11,840		
DTC-1212-PAD1	1,903.7	314	11	33.5	8,750	5,530	11,880		
DTC-1212-QAD1	2,031.0	335	15	36.4	8,800	5,530	11,880	5320	1502
DTC-1212-RAD1	2,124.9	350	18.5	38.5	8,850	5,530	11,980		
DTC-1212-SAD1	2,255.7	372	22	41.0	8,890	5,530	11,980		
DTC-1212-PAJ1	1,922.3	317	11	32.7	9,340	5,990	12,470		
DTC-1212-QAJ1	2,057.3	339	15	35.9	9,340	5,990	12,470	5320	1502
DTC-1212-RAJ1	2,172.7	358	18.5	38.1	9,430	5,990	12,560		
DTC-1212-SAJ1	2,297.6	379	22	40.9	9,430	5,990	12,560		
DTC-1212-TAJ1	2,427.5	400	30	43.4	9,480	5,990	12,610		
DTC-1212-PAE1	1,948.3	321	11	33.2	9,660	6,310	12,880	5320	1502
DTC-1212-QAE1	2,075.1	342	15	36.2	9,710	6,310	12,880		
DTC-1212-RAE1	2,188.1	361	18.5	38.3	9,750	6,310	12,970		
DTC-1212-SAE1	2,298.9	379	22	40.8	9,800	6,310	12,970		
DTC-1212-PAK1	1,976.3	326	11	32.1	10,300	6,850	13,560	5320	1502
DTC-1212-QAK1	2,134.3	352	15	35.4	10,340	6,850	13,560		
DTC-1212-RAK1	2,245.5	370	18.5	37.7	10,390	6,850	13,650		
DTC-1212-SAK1	2,348.6	387	22	40.6	10,430	6,850	13,650		
DTC-1212-TAK1	2,518.6	415	30	43.1	10,480	6,850	13,700		

Model	R717 Charge kg - note 3	Internal Coil Volume L	Pump Motor kW	Recirculating Flow Rate L/s	Remote Sump Application		
					Approximate Operating Weight kg	Bottom Outlet Diameter	Volume L
DTC-1212-NAB1	197	1,246	3.7	44.2	9,030	10"	1,440
DTC-1212-PAB1	197	1,246			9,070		
DTC-1212-QAB1	197	1,246			9,070		
DTC-1212-RAB1	197	1,246			9,160		
DTC-1212-SAB1	197	1,246			9,160		
DTC-1212-NAC1	244	1,540			9,980		
DTC-1212-PAC1	244	1,540			10,020		
DTC-1212-QAC1	244	1,540			10,020		
DTC-1212-RAC1	244	1,540			10,120		
DTC-1212-SAC1	244	1,540			10,120		
DTC-1212-NAD1	290	1,834			10,890		
DTC-1212-PAD1	290	1,834			10,930		
DTC-1212-QAD1	290	1,834			10,980		
DTC-1212-RAD1	290	1,834			11,020		
DTC-1212-SAD1	290	1,834			11,070		
DTC-1212-PAJ1	322	2,036			11,520		
DTC-1212-QAJ1	322	2,036			11,570		
DTC-1212-RAJ1	322	2,036			11,610		
DTC-1212-SAJ1	322	2,036			11,660		
DTC-1212-TAJ1	322	2,036			11,700		
DTC-1212-PAE1	337	2,128	11,930				
DTC-1212-QAE1	337	2,128	11,930				
DTC-1212-RAE1	337	2,128	12,020				
DTC-1212-SAE1	337	2,128	12,020				
DTC-1212-PAK1	374	2,364	12,610				
DTC-1212-QAK1	374	2,334	12,610				
DTC-1212-RAK1	374	2,334	12,700				
DTC-1212-SAK1	374	2,334	12,700				
DTC-1212-TAK1	374	2,334	12,750				

3.7m x 3.7m Single Cell

3.0m x 5.5m Single Cell

Use this data for preliminary layouts only. Obtain current drawing from your sales representative.

UPDATE™ web-based selection software, available at spxcooling.com/update provides Cube model recommendations based on customer's specific design requirements.

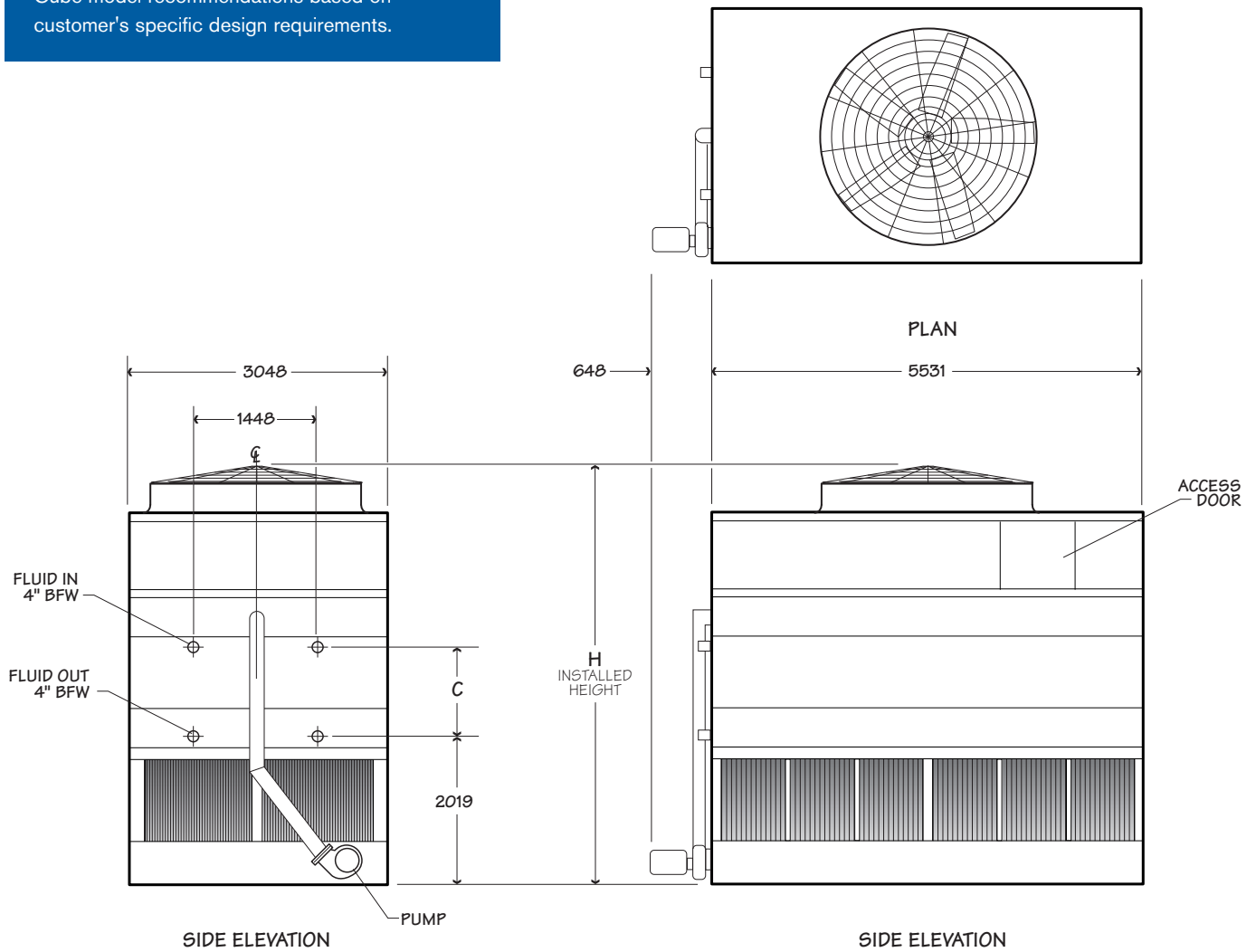

NOTE

1. The last digit of the model number shown represents the number of cells.
2. R717 tons are at 35.7°C condensing temperature, a -6.7°C suction temperature and a 25.6°C entering wet-bulb temperature.
3. For R134a charge, multiply by 1.98. For R22 charge multiply by 1.93. For R404A or R507A charge multiply by 1.65.
4. **Use this bulletin for preliminary layouts only.** Obtain current drawings from your sales representative.

Model note 1	Base Heat Rejection kW	R717 Capacity tons - note 2	Fan Motor kW	Airflow Rate m³/s	Shipping Weight kg		Design Operating Weight kg	Dimensions mm	
					Weight/Cell	Heaviest Section		H	C
DTC-1018-NAB1	1,788.6	295	7.5	34.2	8,620	6,990	12,070	4916"	816
DTC-1018-PAB1	1,932.2	318	11	38.8	8,660	7,080	12,160		
DTC-1018-QAB1	2,048.2	337	15	42.3	8,660	7,080	12,160		
DTC-1018-RAB1	2,136.3	352	18.5	45.0	8,750	7,170	12,200		
DTC-1018-SAB1	2,249.5	371	22	47.8	8,750	7,170	12,250		
DTC-1018-NAC1	1,928.5	318	7.5	33.7	9,750	8,160	13,340	5145	1045
DTC-1018-PAC1	2,102.4	346	11	38.3	9,800	8,210	13,380		
DTC-1018-QAC1	2,229.3	367	15	41.9	9,800	8,210	13,380		
DTC-1018-RAC1	2,336.6	385	18.5	44.6	9,890	8,300	13,470		
DTC-1018-SAC1	2,469.3	407	22	47.5	9,890	8,300	13,470		
DTC-1018-NAD1	2,034.8	335	7.5	33.2	10,800	7,670	14,470	5374	1273
DTC-1018-PAD1	2,221.7	366	11	37.8	10,840	7,670	14,520		
DTC-1018-QAD1	2,378.4	392	15	41.5	10,840	7,670	14,520		
DTC-1018-RAD1	2,490.8	410	18.5	44.3	10,930	7,670	14,610		
DTC-1018-SAD1	2,634.8	434	22	47.3	10,930	7,670	14,610		
DTC-1018-TAD1	2,804.4	462	30	50.6	11,020	7,670	14,700	5602	1502
DTC-1018-PAJ1	2,296.1	378	11	36.9	11,520	8,350	15,240		
DTC-1018-QAJ1	2,457.6	405	15	40.7	11,570	8,350	15,240		
DTC-1018-RAJ1	2,576.3	425	18.5	43.7	11,610	8,350	15,330		
DTC-1018-SAJ1	2,694.0	444	22	46.9	11,660	8,350	15,380		
DTC-1018-TAJ1	2,846.2	469	30	50.5	11,700	8,350	15,420	5602	1502
DTC-1018-PAE1	2,327.1	383	11	37.3	11,980	8,750	15,740		
DTC-1018-QAE1	2,502.8	412	15	41.1	11,980	8,750	15,740		
DTC-1018-RAE1	2,625.3	433	18.5	44.0	12,020	8,750	15,790		
DTC-1018-SAE1	2,783.7	459	22	47.0	12,070	8,750	15,830		
DTC-1018-TAE1	2,963.0	488	30	50.4	12,110	8,750	15,880	5602	1502
DTC-1018-PAK1	2,367.9	390	11	36.2	12,750	9,570	16,560		
DTC-1018-QAK1	2,555.1	421	15	40.1	12,750	9,570	16,600		
DTC-1018-RAK1	2,687.5	443	18.5	43.1	12,840	9,570	16,650		
DTC-1018-SAK1	2,831.3	467	22	46.4	12,840	9,570	16,690		
DTC-1018-TAK1	2,995.2	494	30	50.1	12,930	9,570	16,740		

Model	R717 Charge kg - note 3	Internal Coil Volume L	Pump Motor kW	Recirculating Flow Rate L/s	Remote Sump Application		
					Approximate Operating Weight kg	Bottom Outlet Diameter	Volume L
DTC-1018-NAB1	241	1,525	5.5	52.4	11,110	10"	1,820
DTC-1018-PAB1	241	1,525			11,200		
DTC-1018-QAB1	241	1,525			11,200		
DTC-1018-RAB1	241	1,525			11,290		
DTC-1018-SAB1	241	1,525			11,290		
DTC-1018-NAC1	299	1,891			12,380		
DTC-1018-PAC1	299	1,891			12,430		
DTC-1018-QAC1	299	1,891			12,430		
DTC-1018-RAC1	299	1,891			12,520		
DTC-1018-SAC1	299	1,891			12,520		
DTC-1018-NAD1	357	2,258			13,520		
DTC-1018-PAD1	357	2,258			13,560		
DTC-1018-QAD1	357	2,258			13,560		
DTC-1018-RAD1	357	2,258			13,650		
DTC-1018-SAD1	357	2,258			13,650		
DTC-1018-TAD1	357	2,258			13,740		
DTC-1018-PAJ1	397	2,512			14,290		
DTC-1018-QAJ1	397	2,512			14,330		
DTC-1018-RAJ1	397	2,512			14,380		
DTC-1018-SAJ1	397	2,512			14,420		
DTC-1018-TAJ1	397	2,512			14,470		
DTC-1018-PAE1	415	2,624			14,790		
DTC-1018-QAE1	415	2,624			14,790		
DTC-1018-RAE1	415	2,624			14,880		
DTC-1018-SAE1	415	2,624			14,880		
DTC-1018-TAE1	415	2,624			14,920		
DTC-1018-PAK1	462	2,921			15,600		
DTC-1018-QAK1	462	2,921			15,650		
DTC-1018-RAK1	462	2,921			15,690		
DTC-1018-SAK1	462	2,921			15,740		
DTC-1018-TAK1	462	2,921	15,790				

3.0m x 5.5m Single Cell

3.7m x 5.5m Single Cell

Use this data for preliminary layouts only. Obtain current drawing from your sales representative.

UPDATE™ web-based selection software, available at spxcooling.com/update provides Cube model recommendations based on customer's specific design requirements.

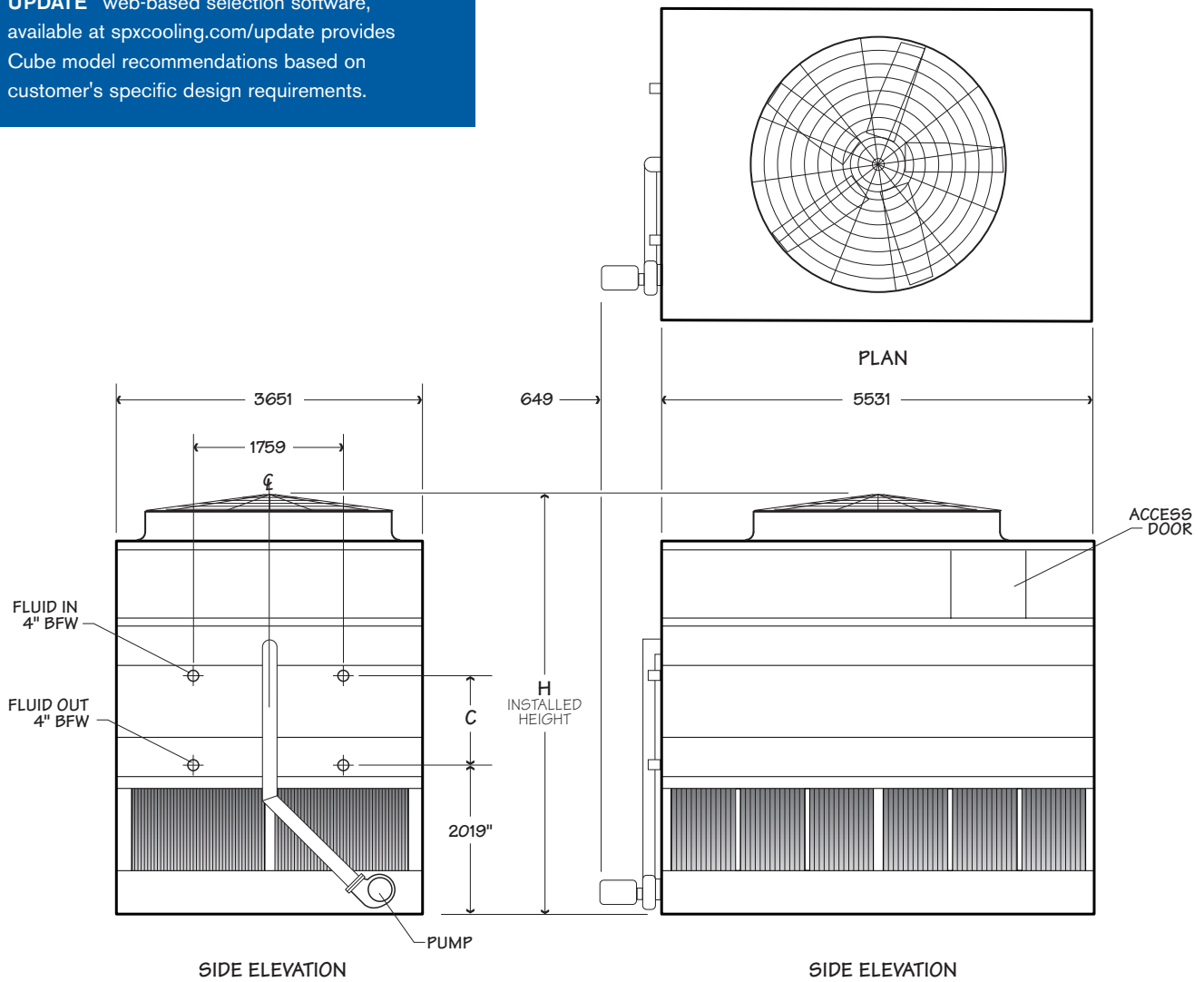

NOTE

1. The last digit of the model number shown represents the number of cells.
2. R717 tons are at 35.7°C condensing temperature, a -6.7°C suction temperature and a 25.6°C entering wet-bulb temperature.
3. For R134a charge, multiply by 1.98. For R22 charge multiply by 1.93. For R404A or R507A charge multiply by 1.65.
4. **Use this bulletin for preliminary layouts only.** Obtain current drawings from your sales representative.

Model note 1	Base Heat Rejection kW	R717 Capacity tons - note 2	Fan Motor kW	Airflow Rate m³/s	Shipping Weight kg		Design Operating Weight kg	Dimensions mm			
					Weight/Cell	Heaviest Section		H	C		
DTC-1218-PAB1	2,251.5	371	11	45.6	9,980	7,480	14,330	5032	816		
DTC-1218-QAB1	2,403.3	396	15	49.8	10,020	7,530	14,330				
DTC-1218-RAB1	2,513.0	414	18.5	52.7	10,070	7,580	14,380				
DTC-1218-SAB1	2,629.8	433	22	55.7	10,120	7,620	14,420				
DTC-1218-PAC1	2,464.0	406	11	45.1	11,340	8,660	15,790				
DTC-1218-QAC1	2,639.9	435	15	49.3	11,340	8,660	15,830	5261	1045		
DTC-1218-RAC1	2,779.5	458	18.5	52.3	11,430	8,750	15,880				
DTC-1218-SAC1	2,900.9	478	22	55.4	11,430	8,750	15,920				
DTC-1218-PAD1	2,621.7	432	11	44.5	12,610	7,890	17,190				
DTC-1218-QAD1	2,825.5	466	15	48.9	12,610	7,890	17,190				
DTC-1218-RAD1	2,962.0	488	18.5	51.8	12,700	7,890	17,280	5490	1273		
DTC-1218-SAD1	3,089.0	509	22	55.0	12,700	7,890	17,330				
DTC-1218-TAD1	3,309.4	545	30	60.0	12,750	7,890	17,370				
DTC-1218-UAD1	3,574.5	589	37	63.0	12,750	7,890	17,370				
DTC-1218-QAJ1	2,893.6	477	15	47.9	13,430	8,620	18,100				
DTC-1218-RAJ1	3,016.2	497	18.5	51.0	13,520	8,620	18,140				
DTC-1218-SAJ1	3,177.6	524	22	54.5	13,520	8,620	18,190				
DTC-1218-TAJ1	3,374.3	556	30	59.8	13,560	8,620	18,230				
DTC-1218-UAJ1	3,522.4	580	37	63.1	13,610	8,620	18,230				
DTC-1218-VAJ1	3,665.6	604	45	65.5	13,740	8,620	18,420				
DTC-1218-QAE1	2,886.2	476	15	48.4	13,930	9,030	18,690			5718	1502
DTC-1218-RAE1	3,020.5	498	18.5	51.4	13,970	9,030	18,730				
DTC-1218-SAE1	3,168.9	522	22	54.7	14,020	9,030	18,780				
DTC-1218-TAE1	3,419.0	563	30	59.7	14,060	9,030	18,820				
DTC-1218-UAE1	3,579.6	590	37	62.8	14,060	9,030	18,820				
DTC-1218-QAK1	2,955.5	487	15	47.2	14,880	9,840	19,690				
DTC-1218-RAK1	3,246.1	535	18.5	53.0	14,970	9,840	19,780				
DTC-1218-SAK1	3,265.0	538	22	53.9	14,970	9,840	19,780				
DTC-1218-TAK1	3,507.8	578	30	59.3	15,010	9,840	19,820				
DTC-1218-UAK1	3,702.0	610	37	62.7	15,010	9,840	19,820				
DTC-1218-VAK1	3,859.8	636	45	65.4	15,200	9,840	20,000				

Model	R717 Charge kg - note 3	Internal Coil Volume L	Pump Motor kW	Recirculating Flow Rate L/s	Remote Sump Application		
					Approximate Operating Weight kg	Bottom Outlet Diameter	Volume L
DTC-1218-PAB1	292	1,843	5.5	59.3	12,470	10"	2,160
DTC-1218-QAB1	292	1,843			12,520		
DTC-1218-RAB1	292	1,843			12,560		
DTC-1218-SAB1	292	1,843			12,610		
DTC-1218-PAC1	362	2,287			13,930		
DTC-1218-QAC1	362	2,287			13,930		
DTC-1218-RAC1	362	2,287			13,970		
DTC-1218-SAC1	362	2,287			14,020		
DTC-1218-PAD1	432	2,730			15,240		
DTC-1218-QAD1	432	2,730			15,240		
DTC-1218-RAD1	432	2,730			15,330		
DTC-1218-SAD1	432	2,730			15,330		
DTC-1218-TAD1	432	2,730			15,380		
DTC-1218-UAD1	432	2,730			15,380		
DTC-1218-QAJ1	480	3,035			16,060		
DTC-1218-RAJ1	480	3,035			16,150		
DTC-1218-SAJ1	480	3,035			16,150		
DTC-1218-TAJ1	480	3,035			16,240		
DTC-1218-UAJ1	480	3,035			16,240		
DTC-1218-VAJ1	480	3,035			16,420		
DTC-1218-QAE1	502	3,173			16,650		
DTC-1218-RAE1	502	3,173			16,740		
DTC-1218-SAE1	502	3,173			16,740		
DTC-1218-TAE1	502	3,173			16,780		
DTC-1218-UAE1	502	3,173			16,830		
DTC-1218-QAK1	558	3,529			17,650		
DTC-1218-RAK1	558	3,529			17,690		
DTC-1218-SAK1	558	3,529			17,740		
DTC-1218-TAK1	558	3,529			17,780		
DTC-1218-UAK1	558	3,529			17,780		
DTC-1218-VAK1	558	3,529	17,960				

3.7m x 5.5m Single Cell

2.6m x 5.5m Two Cell

Use this data for preliminary layouts only. Obtain current drawing from your sales representative.

UPDATE™ web-based selection software, available at spxcooling.com/update provides Cube model recommendations based on customer's specific design requirements.

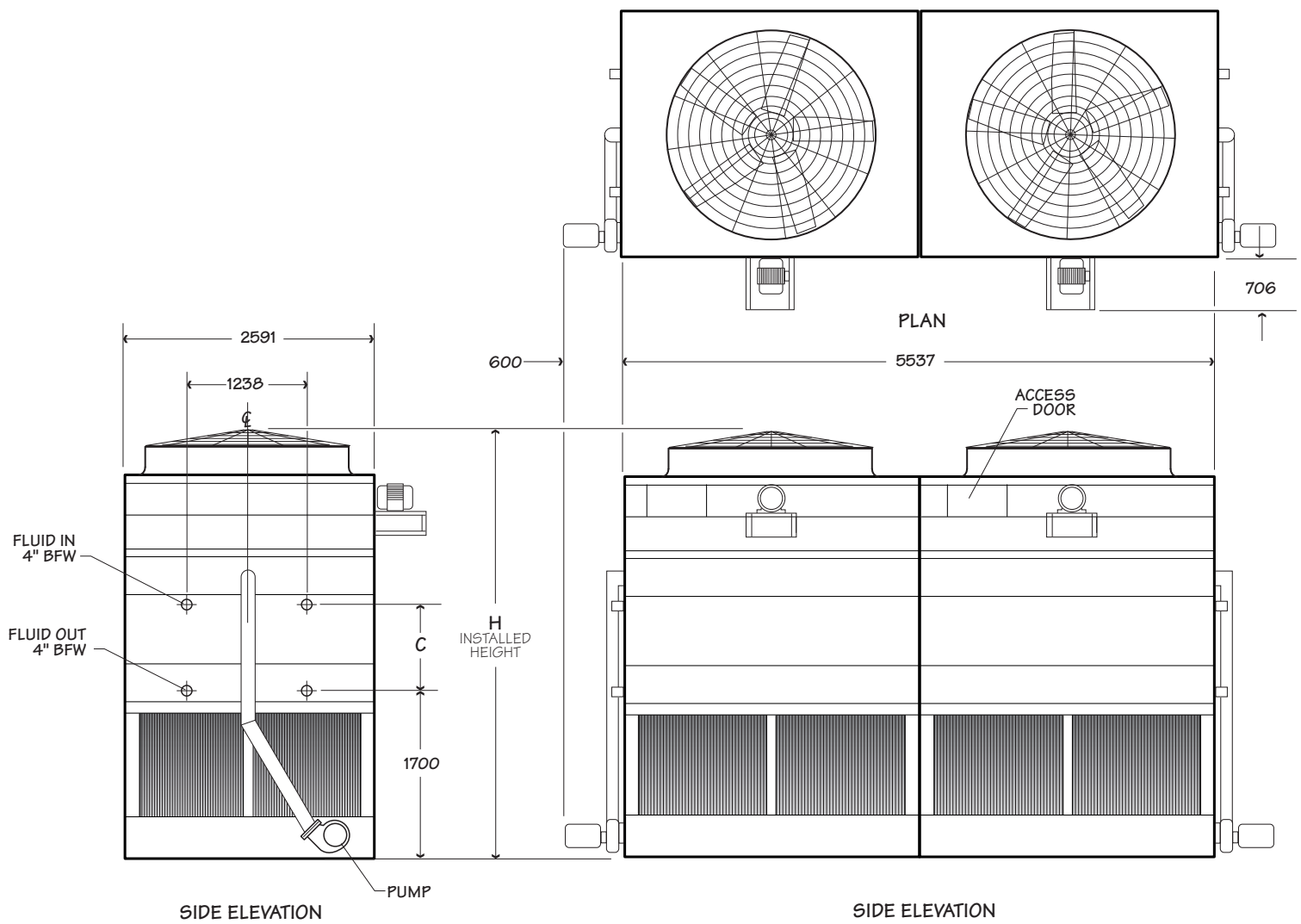

NOTE

1. The last digit of the model number shown represents the number of cells.
2. R717 tons are at 35.7°C condensing temperature, a -6.7°C suction temperature and a 25.6°C entering wet-bulb temperature.
3. For R134a charge, multiply by 1.98. For R22 charge multiply by 1.93. For R404A or R507A charge multiply by 1.65.
4. **Use this bulletin for preliminary layouts only.** Obtain current drawings from your sales representative.

Model note 1	Base Heat Rejection kW	R717 Capacity tons - note 2	Fan Motor kW	Airflow Rate m³/s	Shipping Weight kg		Design Operating Weight kg	Dimensions mm	
					Weight/Cell	Heaviest Section		H	C
DTC-8509-MAB2	1,645.3	271	2 x 5.5	37.0	4,130	3,450	10,610	4077	816
DTC-8509-NAB2	1,738.7	287	2 x 7.5	39.8	4,130	3,450	10,700		
DTC-8509-PAB2	1,909.8	315	2 x 11	44.1	4,220	3,490	10,800		
DTC-8509-QAB2	1,992.0	328	2 x 15	45.8	4,220	3,490	10,800		
DTC-8509-MAC2	1,792.2	295	2 x 5.5	36.6	4,630	3,900	11,610	4305	1045
DTC-8509-NAC2	1,901.4	313	2 x 7.5	39.5	4,630	3,900	11,700		
DTC-8509-PAC2	2,092.2	345	2 x 11	43.9	4,670	3,950	11,790		
DTC-8509-QAC2	2,187.3	360	2 x 15	45.6	4,670	3,990	11,790		
DTC-8509-MAD2	1,902.5	313	2 x 5.5	36.3	5,080	4,350	12,610	4534	1273
DTC-8509-NAD2	2,024.4	334	2 x 7.5	39.2	5,080	4,400	12,610		
DTC-8509-PAD2	2,243.1	370	2 x 11	43.7	5,130	4,450	12,790		
DTC-8509-QAD2	2,336.2	385	2 x 15	45.5	5,170	4,450	12,790		
DTC-8509-MAJ2	1,949.6	321	2 x 5.5	35.3	5,350	4,670	13,250		
DTC-8509-NAJ2	2,066.2	340	2 x 7.5	38.5	5,400	4,670	13,250		
DTC-8509-PAJ2	2,265.8	373	2 x 11	43.4	5,440	4,720	13,340		
DTC-8509-QAJ2	2,359.9	389	2 x 15	45.4	5,440	4,720	13,430		
DTC-8509-MAE2	1,998.1	329	2 x 5.5	35.9	5,580	4,850	13,700	4763	1502
DTC-8509-NAE2	2,134.8	352	2 x 7.5	38.9	5,580	4,900	13,700		
DTC-8509-PAE2	2,362.3	389	2 x 11	43.5	5,620	4,940	13,790		
DTC-8509-QAE2	2,475.0	408	2 x 15	45.3	5,670	4,940	13,880		
DTC-8509-MAK2	2,027.5	334	2 x 5.5	34.7	5,900	5,220	14,420		
DTC-8509-NAK2	2,163.7	357	2 x 7.5	38.0	5,940	5,220	14,420		
DTC-8509-PAK2	2,388.9	394	2 x 11	43.0	5,990	5,260	14,520		
DTC-8509-QAK2	2,492.2	411	2 x 15	45.1	5,990	5,260	14,520		

Model	R717 Charge kg - note 3	Internal Coil Volume L	Pump Motor kW	Recirculating Flow Rate L/s	Remote Sump Application		
					Approximate Operating Weight kg	Bottom Outlet Diameter	Volume L
DTC-8509-MAB2	206	1,302	2 x 1.5	44.8	9,980	2 x 8"	1,670
DTC-8509-NAB2	206	1,302			10,070		
DTC-8509-PAB2	206	1,302			10,160		
DTC-8509-QAB2	206	1,302			10,160		
DTC-8509-MAC2	206	1,602			10,980		
DTC-8509-NAC2	206	1,602			11,070		
DTC-8509-PAC2	206	1,602			11,160		
DTC-8509-QAC2	206	1,602			11,160		
DTC-8509-MAD2	305	1,902			11,980		
DTC-8509-NAD2	305	1,902			11,980		
DTC-8509-PAD2	305	1,902			12,160		
DTC-8509-QAD2	305	1,902			12,160		
DTC-8509-MAJ2	305	2,100			12,610		
DTC-8509-NAJ2	305	2,100			12,610		
DTC-8509-PAJ2	305	2,100			12,700		
DTC-8509-QAJ2	305	2,100			12,790		
DTC-8509-MAE2	349	2,202			13,060		
DTC-8509-NAE2	349	2,202			13,060		
DTC-8509-PAE2	349	2,202			13,150		
DTC-8509-QAE2	349	2,202			13,250		
DTC-8509-MAK2	386	2,433			13,790		
DTC-8509-NAK2	386	2,433			13,790		
DTC-8509-PAK2	386	2,433			13,880		
DTC-8509-QAK2	386	2,433			13,880		

2.6m x 5.5m Two Cell.

2.6m x 7.3m Two Cell

Use this data for preliminary layouts only. Obtain current drawing from your sales representative.

UPDATE™ web-based selection software, available at spxcooling.com/update provides Cube model recommendations based on customer's specific design requirements.

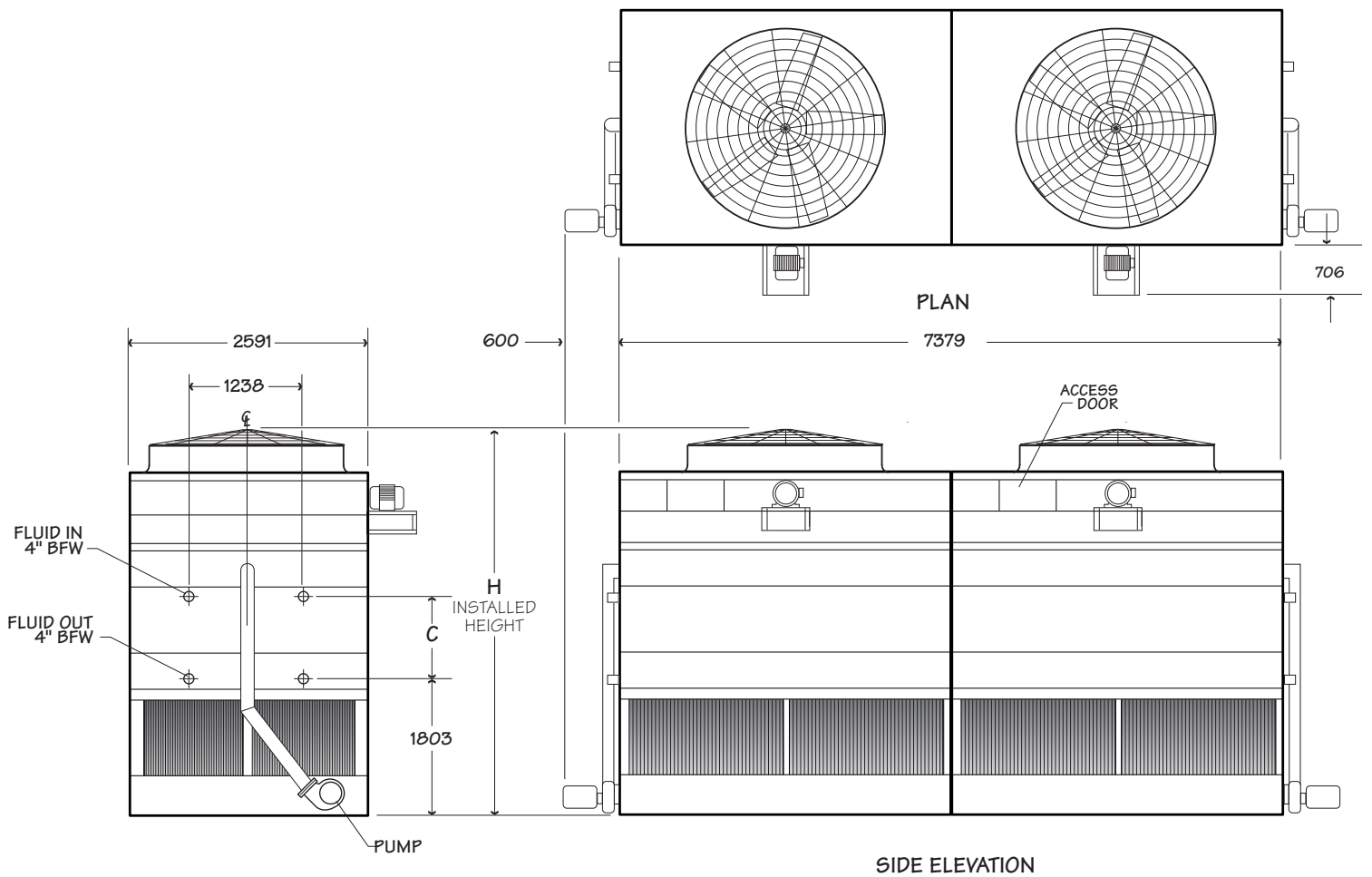

NOTE

1. The last digit of the model number shown represents the number of cells.
2. R717 tons are at 35.7°C condensing temperature, a -6.7°C suction temperature and a 25.6°C entering wet-bulb temperature.
3. For R134a charge, multiply by 1.98. For R22 charge multiply by 1.93. For R404A or R507A charge multiply by 1.65.
4. **Use this bulletin for preliminary layouts only.** Obtain current drawings from your sales representative.

Model note 1	Base Heat Rejection kW	R717 Capacity tons - note 2	Fan Motor kW	Airflow Rate m³/s	Shipping Weight kg		Design Operating Weight kg	Dimensions mm	
					Weight/Cell	Heaviest Section		H	C
DTC-8512-NAB2	2,244.5	370	2 x 7.5	48.2	4,940	4,080	13,060	4178	816
DTC-8512-PAB2	2,468.1	407	2 x 11	54.0	4,990	4,130	13,150		
DTC-8512-OAB2	2,599.4	428	2 x 15	57.1	4,990	4,130	13,250		
DTC-8512-RAB2	2,687.2	443	2 x 18.5	58.9	5,080	4,220	13,340		
DTC-8512-NAC2	2,467.8	407	2 x 7.5	47.7	5,530	4,670	14,330	4407	1045
DTC-8512-PAC2	2,708.9	446	2 x 11	53.7	5,580	4,720	14,420		
DTC-8512-OAC2	2,856.8	471	2 x 15	56.8	5,620	4,760	14,520		
DTC-8512-RAC2	2,955.4	487	2 x 18.5	58.7	5,670	4,810	14,610		
DTC-8512-NAD2	2,625.2	433	2 x 7.5	47.3	6,120	5,260	15,600	4636	1273
DTC-8512-PAD2	2,900.3	478	2 x 11	53.4	6,210	5,350	15,690		
DTC-8512-OAD2	3,072.8	506	2 x 15	56.6	6,210	5,350	15,790		
DTC-8512-RAD2	3,175.5	523	2 x 18.5	58.5	6,310	5,440	15,880		
DTC-8512-SAD2	3,247.6	535	2 x 22	59.7	6,310	5,440	15,970		
DTC-8512-NAJ2	2,681.9	442	2 x 7.5	46.7	6,530	5,670	16,420		
DTC-8512-PAJ2	2,924.1	482	2 x 11	52.7	6,580	5,720	16,510		
DTC-8512-OAJ2	3,074.3	507	2 x 15	56.1	6,580	5,720	16,510		
DTC-8512-RAJ2	3,180.1	524	2 x 18.5	58.1	6,670	5,810	16,690		
DTC-8512-SAJ2	3,236.9	533	2 x 22	59.5	6,670	5,810	16,690		
DTC-8512-NAE2	2,759.6	455	2 x 7.5	46.8	6,760	5,900	16,960	4864	1502
DTC-8512-PAE2	3,052.2	503	2 x 11	53.1	6,850	5,990	17,060		
DTC-8512-OAE2	3,226.8	532	2 x 15	56.3	6,850	5,990	17,060		
DTC-8512-RAE2	3,338.5	550	2 x 18.5	58.2	6,940	6,080	17,240		
DTC-8512-SAE2	3,447.4	568	2 x 22	59.9	6,940	6,080	17,240		
DTC-8512-NAK2	2,775.5	457	2 x 7.5	45.4	7,210	6,350	17,870		
DTC-8512-PAK2	3,081.6	508	2 x 11	52.2	7,260	6,400	17,960		
DTC-8512-OAK2	3,240.4	534	2 x 15	55.6	7,260	6,400	17,960		
DTC-8512-RAK2	3,343.0	551	2 x 18.5	57.7	7,350	6,490	18,140		
DTC-8512-SAK2	3,411.5	562	2 x 22	59.1	7,350	6,490	18,140		

Model	R717 Charge kg - note 3	Internal Coil Volume L	Pump Motor kW	Recirculating Flow Rate L/s	Remote Sump Application		
					Approximate Operating Weight kg	Bottom Outlet Diameter	Volume L
DTC-8512-NAB2	278	1,730	2 x 2.2	66.9	12,070	2 x 8"	2,040
DTC-8512-PAB2	278	1,730			12,160		
DTC-8512-OAB2	278	1,730			12,250		
DTC-8512-RAB2	278	1,730			12,340		
DTC-8512-NAC2	341	2,137			13,340		
DTC-8512-PAC2	341	2,137			13,430		
DTC-8512-OAC2	341	2,137			13,520		
DTC-8512-RAC2	341	2,137			13,610		
DTC-8512-NAD2	404	2,544			14,610		
DTC-8512-PAD2	404	2,544			14,700		
DTC-8512-OAD2	404	2,544			14,790		
DTC-8512-RAD2	404	2,544			14,880		
DTC-8512-SAD2	404	2,544			14,970		
DTC-8512-NAJ2	448	2,813			15,420		
DTC-8512-PAJ2	448	2,813			15,510		
DTC-8512-OAJ2	448	2,813			15,510		
DTC-8512-RAJ2	448	2,813			15,690		
DTC-8512-SAJ2	448	2,813			15,690		
DTC-8512-NAE2	466	2,951			15,970		
DTC-8512-PAE2	466	2,951			16,060		
DTC-8512-OAE2	466	2,951			16,060		
DTC-8512-RAE2	466	2,951			16,240		
DTC-8512-SAE2	466	2,951			16,240		
DTC-8512-NAK2	520	3,265			16,870		
DTC-8512-PAK2	520	3,265			16,960		
DTC-8512-OAK2	520	3,265			16,960		
DTC-8512-RAK2	520	3,265			17,150		
DTC-8512-SAK2	520	3,265			17,150		

2.6m x 7.3m Two Cell

3.0m x 7.3m Two Cell

Use this data for preliminary layouts only. Obtain current drawing from your sales representative.

UPDATE™ web-based selection software, available at spxcooling.com/update provides Cube model recommendations based on customer's specific design requirements.

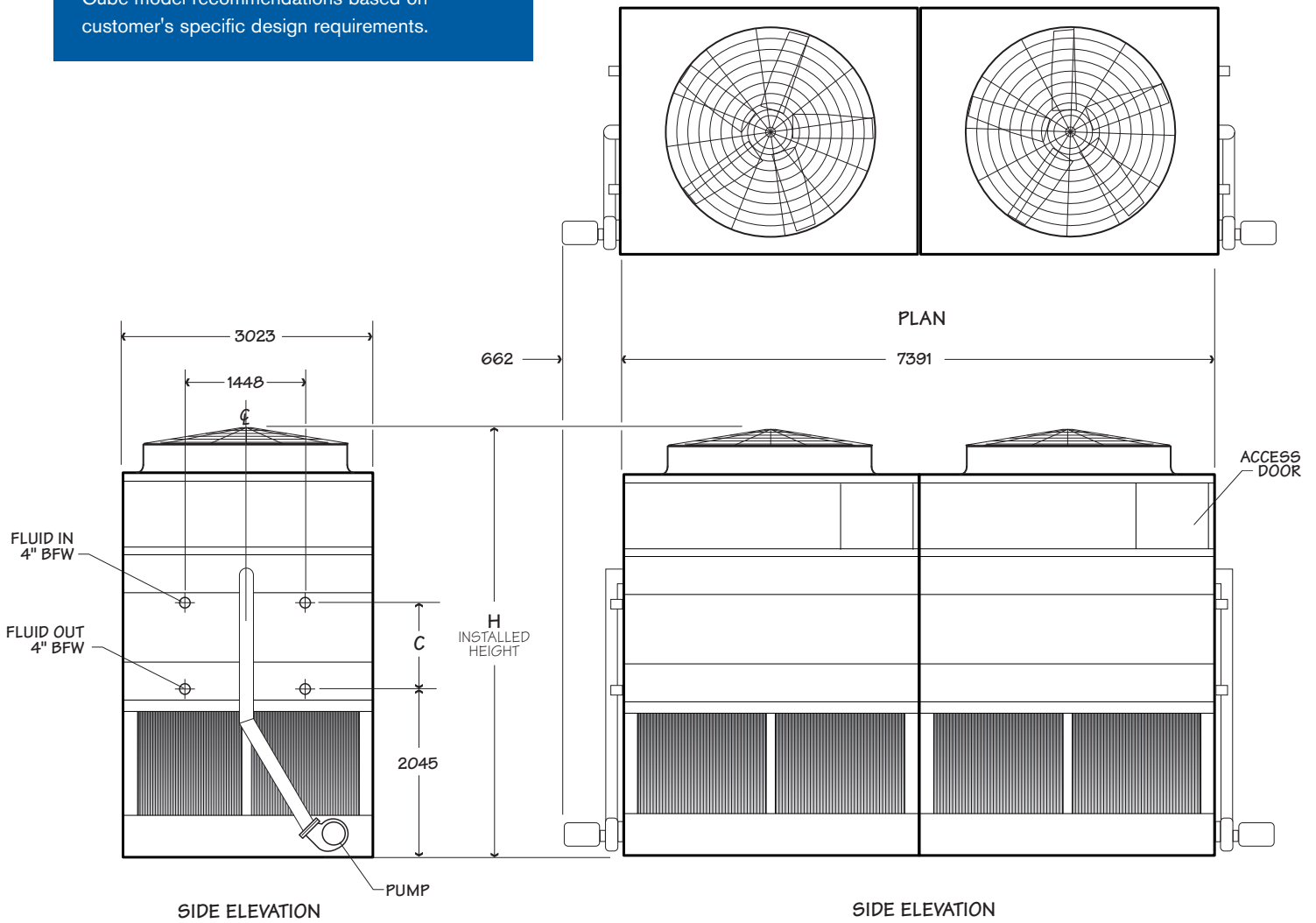

NOTE

1. The last digit of the model number shown represents the number of cells.
2. R717 tons are at 96.3°F condensing temperature, a 20°F suction temperature and a 78°F entering wet-bulb temperature.
3. For R134a charge, multiply by 1.98. For R22 charge multiply by 1.93. For R404A or R507A charge multiply by 1.65.
4. **Use this bulletin for preliminary layouts only.** Obtain current drawings from your sales representative.

Model note 1	Base Heat Rejection kW	R717 Capacity tons - note 2	Fan Motor kW	Airflow Rate m³/s	Shipping Weight kg		Design Operating Weight kg	Dimensions mm			
					Weight/Cell	Heaviest Section		H	C		
DTC-1012-NAB2	2,476.1	408	2 x 7.5	52.3	6,240	5,170	17,190	4942	816		
DTC-1012-PAB2	2,718.8	448	2 x 11	57.4	6,280	5,220	17,330				
DTC-1012-QAB2	2,887.7	476	2 x 15	61.9	6,310	5,220	17,330				
DTC-1012-RAB2	3,003.5	495	2 x 18.5	65.0	6,370	5,310	17,460				
DTC-1012-NAC2	2,788.6	459	2 x 7.5	51.7	6,940	5,900	18,780	5170	1045		
DTC-1012-PAC2	2,985.9	492	2 x 11	56.8	7,010	5,940	18,870				
DTC-1012-QAC2	3,192.2	526	2 x 15	61.5	7,010	5,940	18,920				
DTC-1012-RAC2	3,374.3	556	2 x 18.5	64.6	7,100	6,030	19,050				
DTC-1012-NAD2	2,876.6	474	2 x 7.5	50.9	7,670	5,350	20,320	5399	1273		
DTC-1012-PAD2	3,114.7	513	2 x 11	56.3	7,730	5,350	20,460				
DTC-1012-QAD2	3,323.5	548	2 x 15	61.0	7,730	5,350	20,460				
DTC-1012-RAD2	3,592.7	592	2 x 18.5	64.3	7,800	5,350	20,640				
DTC-1012-SAD2	3,790.7	625	2 x 22	68.8	7,820	5,350	20,680				
DTC-1012-NAJ2	3,040.8	501	2 x 7.5	49.4	8,140	5,810	21,320				
DTC-1012-PAJ2	3,274.8	540	2 x 11	54.9	8,190	5,810	21,460				
DTC-1012-QAJ2	3,490.4	575	2 x 15	60.1	8,210	5,810	21,460				
DTC-1012-RAJ2	3,638.3	600	2 x 18.5	63.7	8,280	5,810	21,590				
DTC-1012-SAJ2	3,835.5	632	2 x 22	68.6	8,300	5,810	21,640				
DTC-1012-PAE2	3,358.5	553	2 x 11	55.7	8,480	6,080	22,090			5628	1502
DTC-1012-QAE2	3,599.4	593	2 x 15	60.6	8,510	6,080	22,140				
DTC-1012-RAE2	3,778.4	623	2 x 18.5	63.9	8,570	6,080	22,270				
DTC-1012-SAE2	3,926.3	647	2 x 22	68.5	8,600	6,080	22,320				
DTC-1012-PAK2	3,418.7	563	2 x 11	53.9	9,030	6,620	23,220				
DTC-1012-QAK2	3,655.8	602	2 x 15	59.3	9,030	6,620	23,270				
DTC-1012-RAK2	3,827.9	631	2 x 18.5	63.0	9,120	6,620	23,410				
DTC-1012-SAK2	3,969.0	654	2 x 22	68.1	9,120	6,620	23,450				

Model	R717 Charge kg - note 3	Internal Coil Volume L	Pump Motor kW	Recirculating Flow Rate L/s	Remote Sump Application		
					Approximate Operating Weight kg	Bottom Outlet Diameter	Volume L
DTC-1012-NAB2	326	2,062	2 x 3.7	75.7	16,100	2 x 8"	2,570
DTC-1012-PAB2	326	2,062			16,190		
DTC-1012-QAB2	326	2,062			16,240		
DTC-1012-RAB2	326	2,062			16,370		
DTC-1012-NAC2	403	2,548			17,650		
DTC-1012-PAC2	403	2,548			17,780		
DTC-1012-QAC2	403	2,548			17,780		
DTC-1012-RAC2	403	2,548			17,960		
DTC-1012-NAD2	480	3,034			19,230		
DTC-1012-PAD2	480	3,034			19,320		
DTC-1012-QAD2	480	3,034			19,370		
DTC-1012-RAD2	480	3,034			19,500		
DTC-1012-SAD2	480	3,034			19,550		
DTC-1012-NAJ2	533	3,370			20,230		
DTC-1012-PAJ2	533	3,370			20,320		
DTC-1012-QAJ2	533	3,370			20,370		
DTC-1012-RAJ2	533	3,370			20,500		
DTC-1012-SAJ2	533	3,370			20,550		
DTC-1012-PAE2	557	3,520			21,000		
DTC-1012-QAE2	557	3,520			21,000		
DTC-1012-RAE2	557	3,520	21,140				
DTC-1012-SAE2	557	3,520	21,180				
DTC-1012-PAK2	619	3,913	22,140				
DTC-1012-QAK2	619	3,913	22,140				
DTC-1012-RAK2	619	3,913	22,320				
DTC-1012-SAK2	619	3,913	22,320				

3.0m x 7.3m Two Cell

3.7m x 7.3m Two Cell

Use this data for preliminary layouts only. Obtain current drawing from your sales representative.

UPDATE™ web-based selection software, available at spxcooling.com/update provides Cube model recommendations based on customer's specific design requirements.

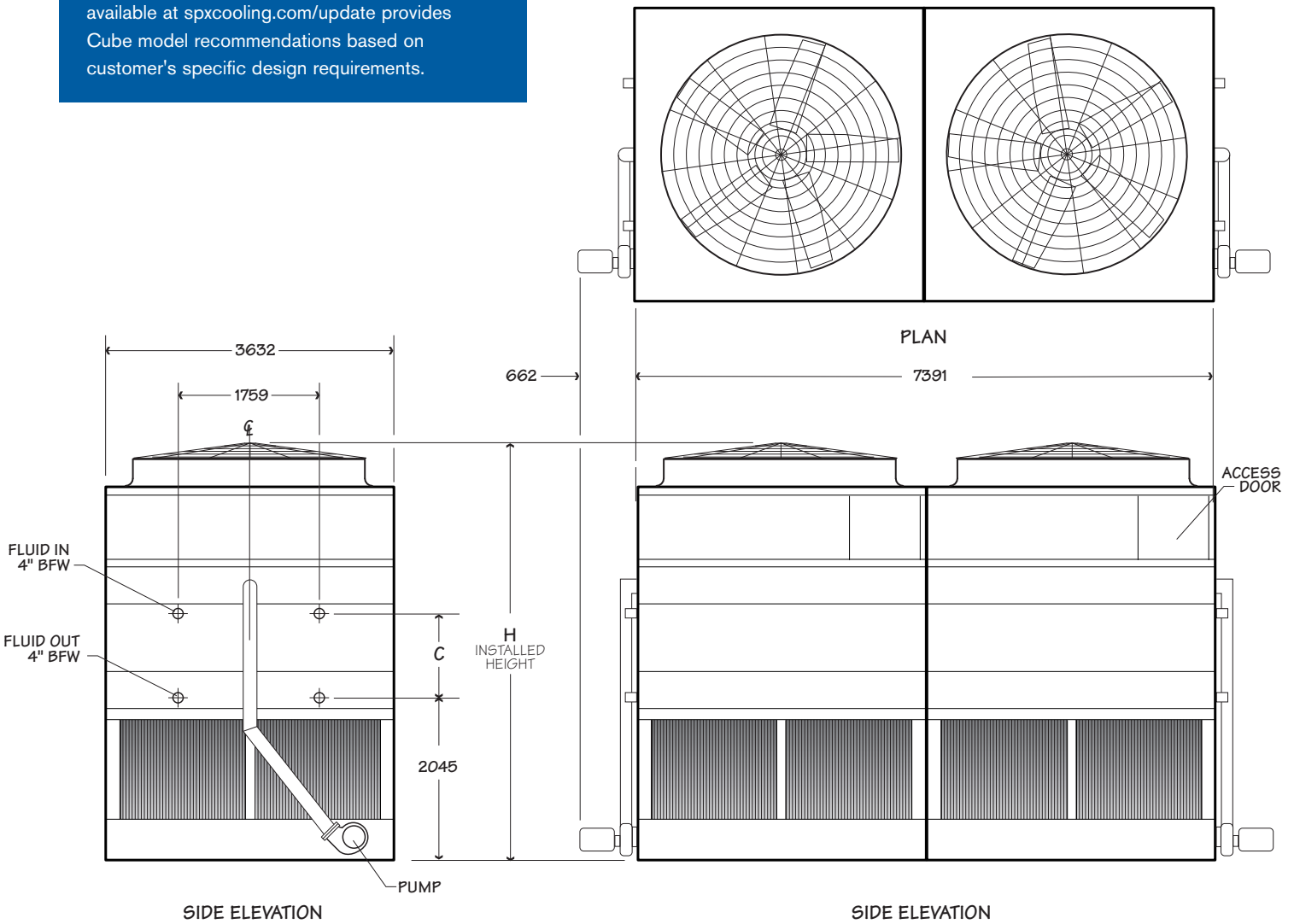

NOTE

1. The last digit of the model number shown represents the number of cells.
2. R717 tons are at 96.3°F condensing temperature, a 20°F suction temperature and a 78°F entering wet-bulb temperature.
3. For R134a charge, multiply by 1.98. For R22 charge multiply by 1.93. For R404A or R507A charge multiply by 1.65.
4. **Use this bulletin for preliminary layouts only.** Obtain current drawings from your sales representative.

Model note 1	Base Heat Rejection kW	R717 Capacity tons - note 2	Fan Motor kW	Airflow Rate m ³ /s	Shipping Weight kg		Design Operating Weight kg	Dimensions mm	
					Weight/Cell	Heaviest Section		H	C
DTC-1212-NAB2	2,943.4	485	2 x 7.5	61.7	7,080	5,940	19,600	4942	816
DTC-1212-PAB2	3,234.7	533	2 x 11	68.5	7,120	5,990	19,730		
DTC-1212-QAB2	3,441.6	567	2 x 15	74.0	7,140	5,990	19,730		
DTC-1212-RAB2	3,588.1	591	2 x 18.5	77.9	7,210	6,080	19,910		
DTC-1212-SAB2	3,764.7	620	2 x 22	82.8	7,230	6,080	19,910		
DTC-1212-NAC2	3,317.9	547	2 x 7.5	60.8	7,940	6,760	21,500	5170	1045
DTC-1212-PAC2	3,544.2	584	2 x 11	67.8	7,980	6,850	21,590		
DTC-1212-QAC2	3,799.1	626	2 x 15	73.4	8,010	6,850	21,640		
DTC-1212-RAC2	4,005.4	660	2 x 18.5	77.5	8,070	6,940	21,770		
DTC-1212-SAC2	4,207.4	693	2 x 22	82.4	8,100	6,940	21,820		
DTC-1212-NAD2	3,511.8	579	2 x 7.5	60.0	8,780	6,260	23,360	5399	1273
DTC-1212-PAD2	3,807.5	627	2 x 11	67.1	8,850	6,260	23,450		
DTC-1212-QAD2	4,062.0	669	2 x 15	72.9	8,850	6,260	23,500		
DTC-1212-RAD2	4,249.9	700	2 x 18.5	77.0	8,940	6,260	23,630		
DTC-1212-SAD2	4,511.4	743	2 x 22	82.0	8,940	6,260	23,680		
DTC-1212-PAJ2	3,844.7	634	2 x 11	65.5	9,390	6,850	24,630	5704	1502
DTC-1212-QAJ2	4,114.7	678	2 x 15	71.8	9,410	6,850	24,680		
DTC-1212-RAJ2	4,345.3	716	2 x 18.5	76.3	9,480	6,850	24,810		
DTC-1212-SAJ2	4,595.2	757	2 x 22	81.8	9,500	6,850	24,860		
DTC-1212-TAJ2	4,855.1	800	2 x 30	86.8	9,550	6,850	24,950		
DTC-1212-PAE2	3,896.5	642	2 x 11	66.3	9,730	7,170	25,400	5704	1502
DTC-1212-QAE2	4,150.2	684	2 x 15	72.3	9,750	7,170	25,450		
DTC-1212-RAE2	4,376.1	721	2 x 18.5	76.5	9,820	7,170	25,580		
DTC-1212-SAE2	4,597.9	758	2 x 22	81.7	9,840	7,170	25,630		
DTC-1212-PAK2	3,952.5	651	2 x 11	64.3	10,390	7,800	26,760		
DTC-1212-QAK2	4,268.7	703	2 x 15	70.8	10,390	7,800	26,810	5704	1502
DTC-1212-RAK2	4,490.9	740	2 x 18.5	75.4	10,480	7,800	26,940		
DTC-1212-SAK2	4,697.3	774	2 x 22	81.1	10,480	7,800	26,990		
DTC-1212-TAK2	5,037.1	830	2 x 30	86.2	10,550	7,800	27,080		

Model	R717 Charge kg - note 3	Internal Coil Volume L	Pump Motor kW	Recirculating Flow Rate L/s	Remote Sump Application		
					Approximate Operating Weight kg	Bottom Outlet Diameter	Volume L
DTC-1212-NAB2	395	2,493	2 x 3.7	88.3	18,190	2 x 10"	3,260
DTC-1212-PAB2	395	2,493			18,330		
DTC-1212-QAB2	395	2,493			18,330		
DTC-1212-RAB2	395	2,493			18,460		
DTC-1212-SAB2	395	2,493			18,510		
DTC-1212-NAC2	488	3,081			20,050		
DTC-1212-PAC2	488	3,081			20,190		
DTC-1212-QAC2	488	3,081			20,190		
DTC-1212-RAC2	488	3,081			20,370		
DTC-1212-SAC2	488	3,081			20,370		
DTC-1212-NAD2	581	3,668			21,950		
DTC-1212-PAD2	581	3,668			22,040		
DTC-1212-QAD2	581	3,668			22,090		
DTC-1212-RAD2	581	3,668			22,230		
DTC-1212-SAD2	581	3,668			22,270		
DTC-1212-PAJ2	645	4,072			23,220		
DTC-1212-QAJ2	645	4,072			23,270		
DTC-1212-RAJ2	645	4,072			23,410		
DTC-1212-SAJ2	645	4,072			23,450		
DTC-1212-TAJ2	645	4,072			23,540		
DTC-1212-PAE2	674	4,256	24,000				
DTC-1212-QAE2	674	4,256	24,000				
DTC-1212-RAE2	674	4,256	24,180				
DTC-1212-SAE2	674	4,256	24,180				
DTC-1212-PAK2	748	4,727	25,360				
DTC-1212-QAK2	748	4,727	25,360				
DTC-1212-RAK2	748	4,727	25,540				
DTC-1212-SAK2	748	4,727	25,540				
DTC-1212-TAK2	748	4,727	25,670				

3.7m x 7.3m Two Cell

3.0m x 11.0m Two Cell

Use this data for preliminary layouts only. Obtain current drawing from your sales representative.

UPDATE™ web-based selection software, available at spxcooling.com/update provides Cube model recommendations based on customer's specific design requirements.

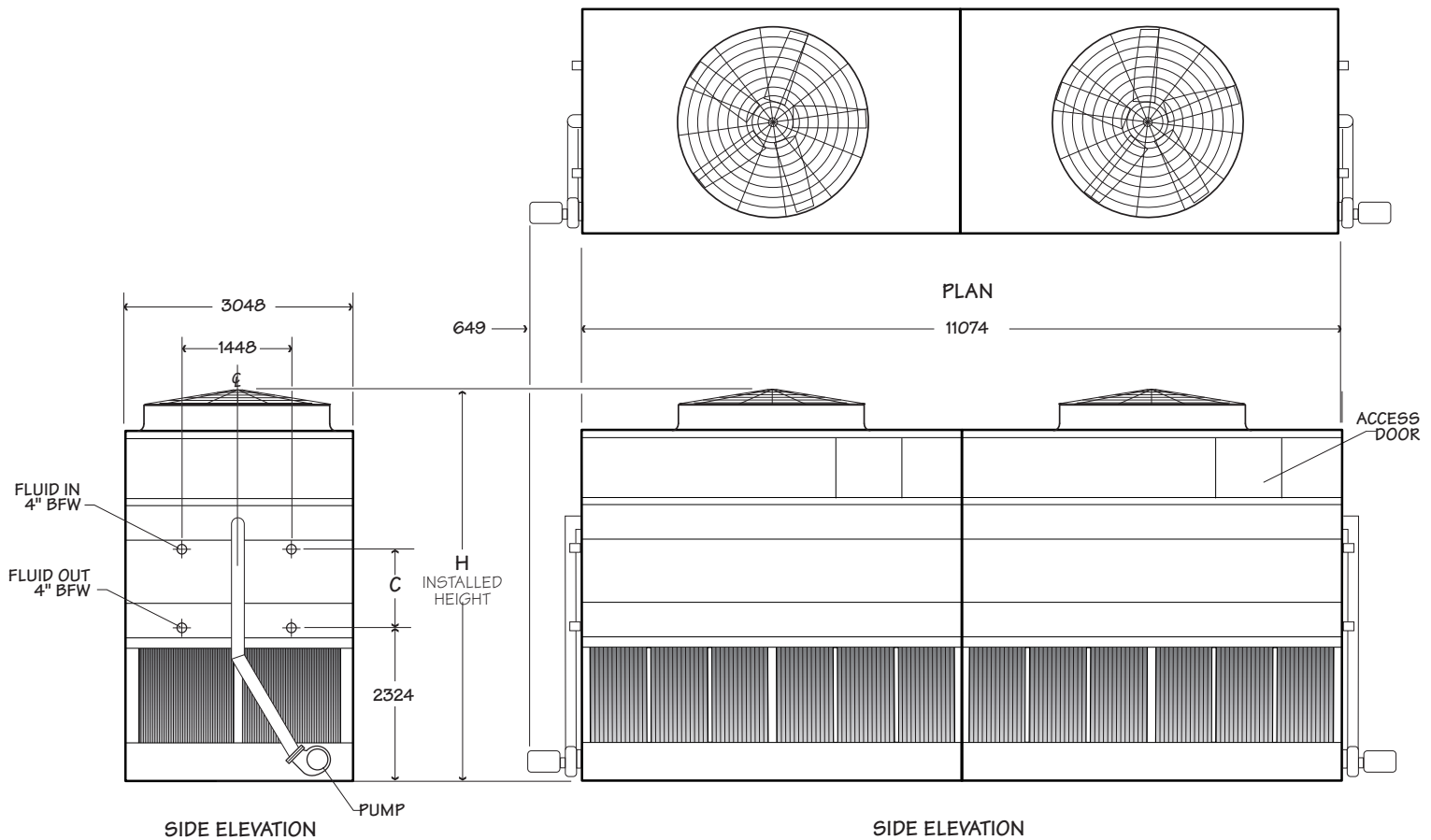

NOTE

1. The last digit of the model number shown represents the number of cells.
2. R717 tons are at 96.3°F condensing temperature, a 20°F suction temperature and a 78°F entering wet-bulb temperature.
3. For R134a charge, multiply by 1.98. For R22 charge multiply by 1.93. For R404A or R507A charge multiply by 1.65.
4. **Use this bulletin for preliminary layouts only.** Obtain current drawings from your sales representative.

Model note 1	Base Heat Rejection kW	R717 Capacity tons - note 2	Fan Motor kW	Airflow Rate m ³ /s	Shipping Weight kg		Design Operating Weight kg	Dimensions mm	
					Weight/Cell	Heaviest Section		H	C
DTC-1018-NAB2	3,577.3	589	2 x 7.5	68.4	8,710	6,990	24,400	5221	816
DTC-1018-PAB2	3,864.5	637	2 x 11	77.5	8,750	7,080	24,490		
DTC-1018-OAB2	4,096.4	675	2 x 15	84.6	8,780	7,080	24,540		
DTC-1018-RAB2	4,272.6	704	2 x 18.5	89.9	8,850	7,170	24,680		
DTC-1018-SAB2	4,499.0	741	2 x 22	95.6	8,870	7,170	24,720		
DTC-1018-NAC2	3,857.0	636	2 x 7.5	67.4	9,840	8,160	26,850	5450	1045
DTC-1018-PAC2	4,204.8	693	2 x 11	76.6	9,890	8,210	26,990		
DTC-1018-OAC2	4,458.7	735	2 x 15	83.8	9,910	8,210	26,990		
DTC-1018-RAC2	4,673.1	770	2 x 18.5	89.3	9,980	8,300	27,130		
DTC-1018-SAC2	4,938.7	814	2 x 22	95.1	10,000	8,300	27,170		
DTC-1018-NAD2	4,069.7	671	2 x 7.5	66.3	10,890	7,670	29,170	5678	1273
DTC-1018-PAD2	4,443.4	732	2 x 11	75.6	10,950	7,670	29,260		
DTC-1018-OAD2	4,756.7	784	2 x 15	83.1	10,950	7,670	29,300		
DTC-1018-RAD2	4,981.6	821	2 x 18.5	88.6	11,020	7,670	29,440		
DTC-1018-SAD2	5,269.6	868	2 x 22	94.6	11,050	7,670	29,480		
DTC-1018-TAD2	5,608.8	924	2 x 30	101.2	11,110	7,670	29,570		
DTC-1018-PAJ2	4,592.2	757	2 x 11	73.7	11,630	8,350	30,710		
DTC-1018-OAJ2	4,915.2	810	2 x 15	81.5	11,660	8,350	30,750		
DTC-1018-RAJ2	5,152.7	849	2 x 18.5	87.3	11,730	8,350	30,890		
DTC-1018-SAJ2	5,387.9	888	2 x 22	93.8	11,750	8,350	30,940		
DTC-1018-TAJ2	5,692.4	938	2 x 30	100.9	11,790	8,350	31,030	5907	1502
DTC-1018-PAE2	4,654.1	767	2 x 11	74.7	12,070	8,750	31,660		
DTC-1018-OAE2	5,005.5	825	2 x 15	82.3	12,070	8,750	31,710		
DTC-1018-RAE2	5,250.6	865	2 x 18.5	87.9	12,130	8,750	31,840		
DTC-1018-SAE2	5,567.5	917	2 x 22	94.0	12,160	8,750	31,890		
DTC-1018-TAE2	5,926.0	976	2 x 30	100.8	12,220	8,750	31,980		
DTC-1018-PAK2	4,735.8	780	2 x 11	72.3	12,860	9,570	33,340		
DTC-1018-OAK2	5,110.1	842	2 x 15	80.2	12,860	9,570	33,380		
DTC-1018-RAK2	5,374.9	886	2 x 18.5	86.2	12,950	9,570	33,520		
DTC-1018-SAK2	5,662.6	933	2 x 22	92.9	12,950	9,570	33,570		
DTC-1018-TAK2	5,990.4	987	2 x 30	100.1	13,020	9,570	33,660		

Model	R717 Charge kg- note 3	Internal Coil Volume L	Pump Motor kW	Recirculating Flow Rate L/s	Remote Sump Application		
					Approximate Operating Weight kg	Bottom Outlet Diameter	Volume L
DTC-1018-NAB2	483	3,049	2 x 5.5	104.7	22,500	2 x 10"	3,630
DTC-1018-PAB2	483	3,049			22,590		
DTC-1018-OAB2	483	3,049			22,630		
DTC-1018-RAB2	483	3,049			22,770		
DTC-1018-SAB2	483	3,049			22,820		
DTC-1018-NAC2	599	3,782			24,990		
DTC-1018-PAC2	599	3,782			25,080		
DTC-1018-OAC2	599	3,782			25,130		
DTC-1018-RAC2	599	3,782			25,270		
DTC-1018-SAC2	599	3,782			25,310		
DTC-1018-NAD2	714	4,515			27,260		
DTC-1018-PAD2	714	4,515			27,350		
DTC-1018-OAD2	714	4,515			27,400		
DTC-1018-RAD2	714	4,515			27,530		
DTC-1018-SAD2	714	4,515			27,580		
DTC-1018-TAD2	714	4,515			27,670		
DTC-1018-PAJ2	795	5,023			28,800		
DTC-1018-OAJ2	795	5,023			28,850		
DTC-1018-RAJ2	795	5,023			28,990		
DTC-1018-SAJ2	795	5,023			29,030		
DTC-1018-TAJ2	795	5,023			29,120		
DTC-1018-PAE2	831	5,248			29,760		
DTC-1018-OAE2	831	5,248			29,800		
DTC-1018-RAE2	831	5,248			29,940		
DTC-1018-SAE2	831	5,248			29,980		
DTC-1018-TAE2	831	5,248			30,070		
DTC-1018-PAK2	924	5,842			31,480		
DTC-1018-OAK2	924	5,842			31,480		
DTC-1018-RAK2	924	5,842			31,620		
DTC-1018-SAK2	924	5,842			31,660		
DTC-1018-TAK2	924	5,842	31,800				

3.0m x 1.0m Two Cell

3.7m x 11.0m Two Cell

Use this data for preliminary layouts only. Obtain current drawing from your sales representative.

UPDATE™ web-based selection software, available at spxcooling.com/update provides Cube model recommendations based on customer's specific design requirements.

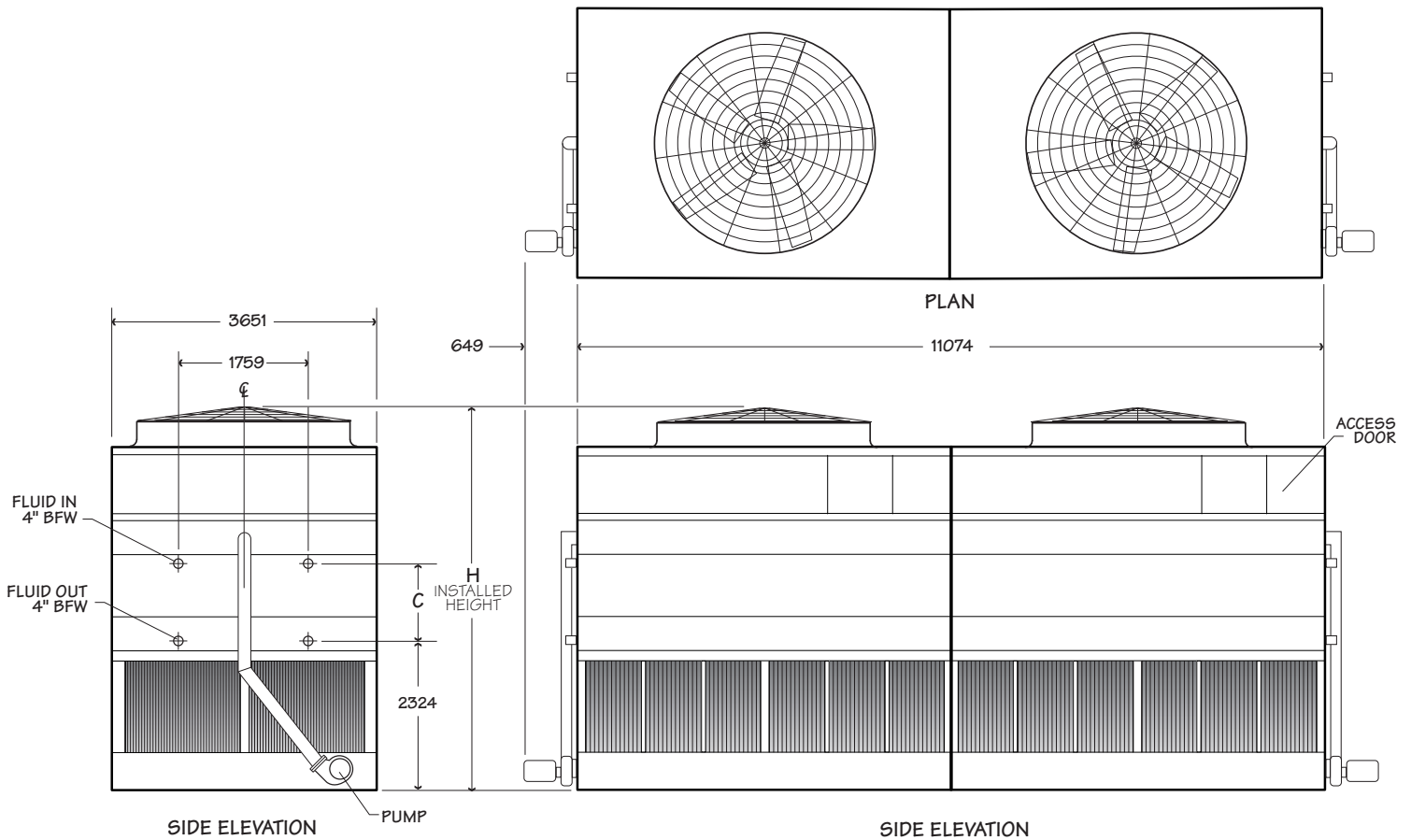

NOTE

1. The last digit of the model number shown represents the number of cells.
2. R717 tons are at 96.3°F condensing temperature, a 20°F suction temperature and a 78°F entering wet-bulb temperature.
3. For R134a charge, multiply by 1.98. For R22 charge multiply by 1.93. For R404A or R507A charge multiply by 1.65.
4. **Use this bulletin for preliminary layouts only.** Obtain current drawings from your sales representative.

Model note 1	Base Heat Rejection kW	R717 Capacity tons - note 2	Fan Motor kW	Airflow Rate m³/s	Shipping Weight kg		Design Operating Weight kg	Dimensions mm	
					Weight/Cell	Heaviest Section		H	C
DTC-1218-PAB2	4,503.1	742	2 x 11	91.3	10,120	8,260	27,310	5388	816
DTC-1218-QAB2	4,806.5	792	2 x 15	99.6	10,120	8,260	27,310		
DTC-1218-RAB2	5,026.0	828	2 x 18.5	105.3	10,180	8,300	27,490		
DTC-1218-SAB2	5,259.5	867	2 x 22	111.5	10,210	8,350	27,490		
DTC-1218-PAC2	4,927.9	812	2 x 11	90.2	11,450	9,570	30,120	5566	1045
DTC-1218-QAC2	5,279.9	870	2 x 15	98.7	11,480	9,620	30,160		
DTC-1218-RAC2	5,559.0	916	2 x 18.5	104.5	11,540	9,660	30,300		
DTC-1218-SAC2	5,801.8	956	2 x 22	110.8	11,570	9,710	30,350		
DTC-1218-PAD2	5,243.5	864	2 x 11	89.0	12,700	9,030	32,800	5794	1273
DTC-1218-QAD2	5,651.0	931	2 x 15	97.7	12,720	9,030	32,800		
DTC-1218-RAD2	5,924.1	976	2 x 18.5	103.7	12,790	9,030	32,930		
DTC-1218-SAD2	6,178.1	1,018	2 x 22	110.1	12,810	9,030	32,980		
DTC-1218-TAD2	6,618.8	1,091	2 x 30	120.0	12,860	9,030	33,110		
DTC-1218-UAD2	7,149.1	1,178	2 x 11	126.1	12,880	9,030	33,110		
DTC-1218-QAJ2	5,787.3	954	2 x 15	95.8	13,540	9,840	34,470		
DTC-1218-RAJ2	6,032.4	994	2 x 18.5	102.0	13,610	9,840	34,610		
DTC-1218-SAJ2	6,355.2	1,047	2 x 22	108.9	13,630	9,840	34,660		
DTC-1218-TAJ2	6,748.5	1,112	2 x 30	119.6	13,680	9,840	34,750		
DTC-1218-UAJ2	7,044.9	1,161	2 x 37	126.2	13,700	9,840	34,790		
DTC-1218-VAJ2	7,331.1	1,208	2 x 45	131.0	13,860	9,840	35,110		
DTC-1218-QAE2	5,772.4	951	2 x 15	96.7	14,040	10,300	35,650	6023	1502
DTC-1218-RAE2	6,040.9	995	2 x 18.5	102.8	14,110	10,300	35,790		
DTC-1218-SAE2	6,337.9	1,044	2 x 22	109.4	14,130	10,300	35,830		
DTC-1218-TAE2	6,838.0	1,127	2 x 30	119.4	14,180	10,300	35,930		
DTC-1218-UAE2	7,159.1	1,180	2 x 37	125.6	14,200	10,300	35,970		
DTC-1218-QAK2	5,911.0	974	2 x 15	94.3	14,990	11,290	37,600		
DTC-1218-RAK2	6,492.3	1,070	2 x 18.5	106.1	15,060	11,290	37,740		
DTC-1218-SAK2	6,530.0	1,076	2 x 22	107.8	15,080	11,290	37,780		
DTC-1218-TAK2	7,015.5	1,156	2 x 30	118.7	15,130	11,290	37,880		
DTC-1218-UAK2	7,404.0	1,220	2 x 37	125.4	15,150	11,290	37,920		
DTC-1218-VAK2	7,719.5	1,272	2 x 45	130.7	15,310	11,290	38,240		

Model	R717 Charge kg - note 3	Internal Coil Volume L	Pump Motor kW	Recirculating Flow Rate L/s	Remote Sump Application		
					Approximate Operating Weight kg	Bottom Outlet Diameter	Volume L
DTC-1218-PAB2	583	3,687	2 x 5.5	118.6	25,220	2 x 10"	4,320
DTC-1218-QAB2	583	3,687			25,220		
DTC-1218-RAB2	583	3,687			25,360		
DTC-1218-SAB2	583	3,687			25,400		
DTC-1218-PAC2	724	4,573			28,030		
DTC-1218-QAC2	724	4,573			28,080		
DTC-1218-RAC2	724	4,573			28,210		
DTC-1218-SAC2	724	4,573			28,260		
DTC-1218-PAD2	864	5,460			30,660		
DTC-1218-QAD2	864	5,460			30,710		
DTC-1218-RAD2	864	5,460			30,840		
DTC-1218-SAD2	864	5,460			30,890		
DTC-1218-TAD2	864	5,460			30,980		
DTC-1218-UAD2	864	5,460			31,030		
DTC-1218-QAJ2	961	6,069			32,390		
DTC-1218-RAJ2	961	6,069			32,520		
DTC-1218-SAJ2	961	6,069			32,570		
DTC-1218-TAJ2	961	6,069			32,660		
DTC-1218-UAJ2	961	6,069			32,700		
DTC-1218-VAJ2	961	6,069			33,020		
DTC-1218-QAE2	1,004	6,346			33,570		
DTC-1218-RAE2	1,004	6,346			33,700		
DTC-1218-SAE2	1,004	6,346			33,750		
DTC-1218-TAE2	1,004	6,346			33,840		
DTC-1218-UAE2	1,004	6,346			33,840		
DTC-1218-QAK2	1,117	7,058			35,520		
DTC-1218-RAK2	1,117	7,058			35,650		
DTC-1218-SAK2	1,117	7,058			35,700		
DTC-1218-TAK2	1,117	7,058			35,790		
DTC-1218-UAK2	1,117	7,058			35,830		
DTC-1218-VAK2	1,117	7,058			36,150		

3.7m x 11.0m Two Cell

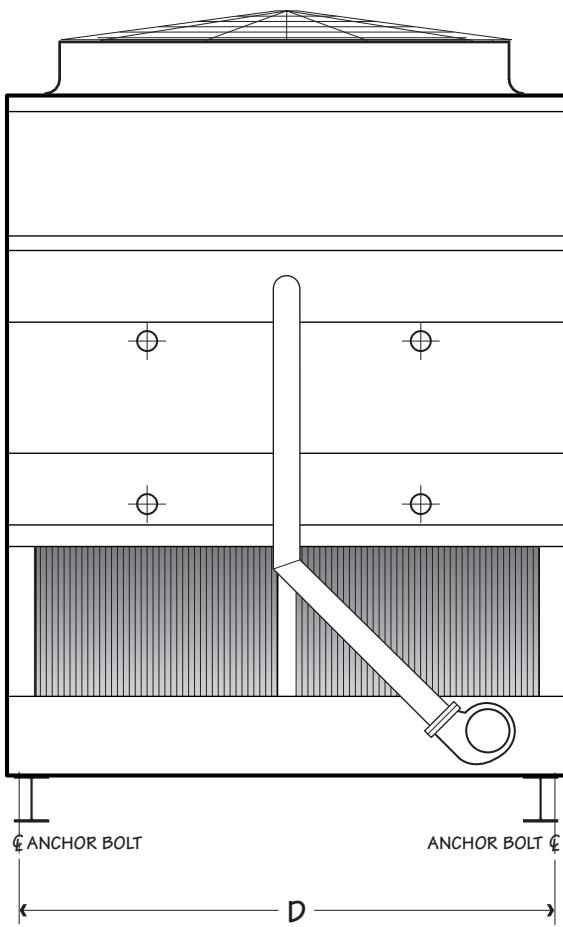

Model	D	Maximum Deflection
DTC-8509	2538	13
DTC-8512	2538	13
DTC-1012	2950	13
DTC-1018	2950	13
DTC-1212	3566	13
DTC-1218	3566	13

NOTE

1. The recommended supporting steel arrangement for the Cube DTC Evap Condenser consists of parallel I-beams running the full length of the unit.
2. Supporting steel is to be designed, constructed and furnished by others.
3. The top surface of the supporting steel must be framed flush and level.
4. If vibration isolators are used, they must be placed underneath the supporting steel beams.
5. Consider provisions for access to the condenser if the supporting steel is elevated above grade.
6. **Use this bulletin for preliminary layouts only.** Obtain current drawings from your sales representative.

The purpose of a basin heater is to prevent recirculating water from freezing in the collection basin during periods of shutdown or standby operation. Heater systems are sized according to tower model and ambient temperature to give maximum protection against freezing in the collection basin. They are not intended to protect the coil and other components from icing.

An automatic basin water heater system consists of the following components:

- Stainless steel electric immersion heater(s). Threaded couplings are provided in the side of the collection basin.
- IP56 enclosure containing:
 - Transformer to convert power supply to 24 volts for control circuit.
 - Magnetic contactor to energize heater.
 - Solid state circuit board for temperature and low-water cutoff.
 - The enclosure may be mounted on the side of the condenser.
- Control probe in the collection basin to monitor water temperature and level.

Heater components are typically shipped separately for installation by others.

Heat trace and insulation of the pump may be optionally selected.

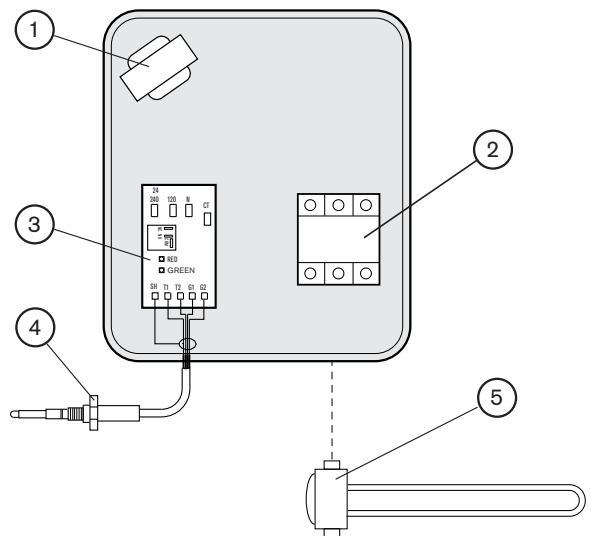

1. Transformer
2. Contactor
3. Solid State Relay Card
4. Sensor Probe
5. Heater Element(s)

Model	Heater Size kW		
	-18°C Ambient	-29°C Ambient	-40°F Ambient
DTC-8509	6	7.5	12
DTC-8512	7.5	12	2 x 7.5
DTC-1012	9	12	2 x 7.5
DTC-1018	12	2 x 9	2 x 12
DTC-1212	12	2 x 7.5	2 x 9
DTC-1218	2 x 7.5	2 x 12	2 x 12

Furnish and install an induced draft, counterflow, evaporative condenser with a condensing capacity of _____ kW heat rejection while operating with _____ refrigerant at _____°C condensing temperature and _____°C entering wet-bulb temperature.

Unit shall consist of _____ cell(s), as shown on plans. The limiting overall dimensions of the condenser shall be _____m wide, _____m long, and _____ high. Total operating power of all fans shall not exceed _____ kW, consisting of _____@ _____ kW motor(s). Tower shall be similar and equal in all aspects to Cube DTC Evaporative Condenser Model _____.

Collection Basin and Casing: The collection basin and casing shall be heavy-gauge Z725 galvanized steel. To reduce potential for leaks, bolts shall be used in all submerged areas; self-tapping screws are not permitted. A factory-installed, float operated, mechanical make-up valve shall be included. An overflow and drain connection shall be provided in each cell. The basin floor shall slope towards the drain to allow complete flushing of debris. The collection basin shall be tested for leaks at the factory.

Fan Motor: Fan motor(s) shall be IEC Premium Efficiency, TEFC, 1.15 service factor, variable torque, inverter ready and insulated for cooling tower duty, with each motor serving a single fan drive assembly. Motors shall be name plated for 3 phase, 50 Hz, _____ volt operation.

Fan: Fan(s) shall be propeller-type, incorporating aluminum alloy blades attached to galvanized hubs with U-bolts. Blades shall be individually adjustable. Fan(s) shall be driven through a right angle, industrial duty, oil lubricated, geared speed reducer that requires no oil changes for the first five (5) years of operation. All gearbox bearings shall be rated at an L_{10A} service life of 100,000 hours or greater and the gear sets shall have AGMA Quality Class of 9 or greater. The top of the fan cylinder shall be equipped with a conical, non-sagging, removable fan guard, fabricated of welded 8mm and 4mm rods, and hot dip galvanized after fabrication.

Pump: Recirculation pump(s) shall be centrifugal with mechanical seal, mounted to the collection basin in conjunction with a suction assembly, and close-coupled with a _____kW TEFC pump motor name plated for 3 phase, 50 Hz, _____volt operation. Recirculation piping shall be schedule 40 PVC. A blowdown line with metering valve shall be connected directly to the evaporative condenser overflow.

Heat Transfer Coil: Condenser coil(s) shall be constructed of continuous serpentine circuits assembled into fully welded headers and hot dip galvanized after fabrication. Each coil shall be tested at 2586 kPa air pressure under water. Coil tubes shall be sloped for free drainage of fluid.

Water Distribution: A pressurized spray system shall distribute water evenly over the coil surface with large-orifice, clog resistant spray nozzles that are threaded for easy removal. The distribution header shall be self-draining, with removable corrosion resistant PVC branch arms.

Drift Eliminators: Drift eliminators shall be .43mm thick PVC with a minimum of three changes in air direction, and shall limit drift losses to 0.001% or less of the design recirculating water flow rate. Eliminators shall be easily removable for inspection.

Louvers: Air inlet louvers shall be a minimum of 125mm air travel, triple pass PVC to limit water splash-out and prevent direct sunlight from entering the collection basin. For ease of service and long life, PVC louvers shall be enclosed in a removable frame that attaches to the air inlet without tools. Louvers with less than three changes in air direction are unacceptable.

SPX COOLING TECHNOLOGIES MALAYSIA SDN BHD

UNIT 505, BLOCK B, PHILEO DAMANSARA 2
NO. 15 JALAN 16/11 OFF JALAN DAMANSARA
46350 PETALING JAYA, MALAYSIA
60 3 7947 7800 | th.my.enquiry@spx.com
spxcooling.com

sea_DTC-TS-16 | ISSUED 06/2016

COPYRIGHT © 2016 SPX CORPORATION

In the interest of technological progress, all products
are subject to design and/or material change without notice.

